

# Newly introducing the two 3 port valves integrated type to complete the series.

The valve block with two 3 port valves integrated type has been newly added to the popular PC compatible reduced wiring 3, 4 port valve block manifold, expanding the variety of available series and variations.

## MN3S0 Series

### Control two air operated valves with one station with the higher integrated and space saving series.

A valve block compactly integrating two 3 port valves has been newly added to the series. A high integration, space saving 3 port valve block manifold which can control two air operated valves with one station, or 16 with eight stations, can be configured.

#### Remarkable footprint reduction

16 stations wide is reduced to 8 stations.  
35 % space reduction. (CKD comparison)

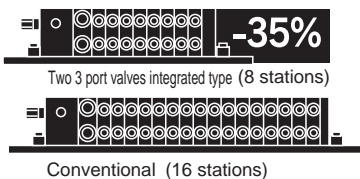

#### Highly reliable exhaust pressure shut out

Each of the 3 port valve is equipped with a compact and highly reliable lead valve, thus preventing miss-operation caused by exhaust pressure.

#### Six types

The N.C./N.O. can be combined freely.

#### Mixed 3, 4 port valve usage

The 3 port and 4 port valves can be mixed within the same manifold.

#### Easy piping work

The N.C./N.O. class is indicated on the piping port, thus facilitating piping work.

#### Control up to $\varnothing 20$ cylinders

Max.  $\varnothing 20$  single-acting cylinder can be controlled.

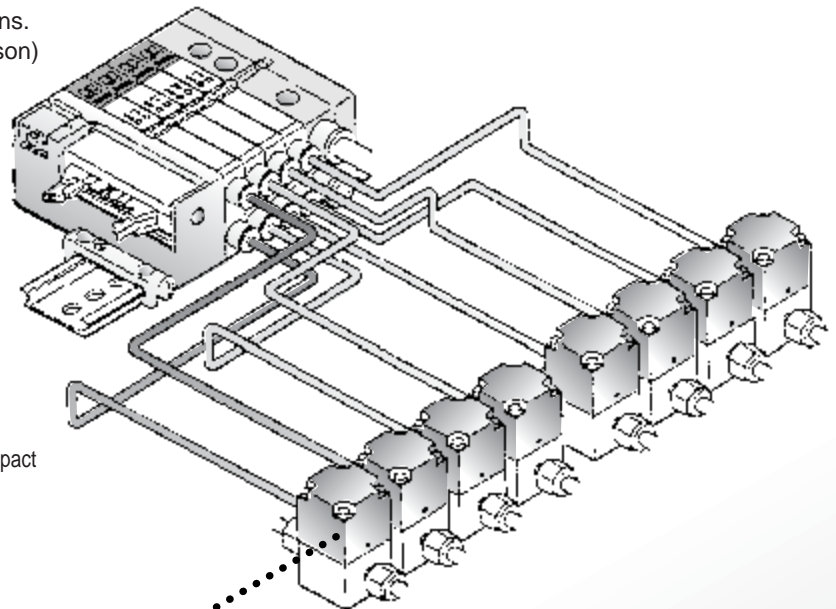

#### Air operated valve

Air operated valve AMD series for chemicals  
A variety of air operated valves suitable for semiconductor manufacturing processes, such as the air operated valve AGD series for process gas, is available. Contact with CKD. (Product illustration example)

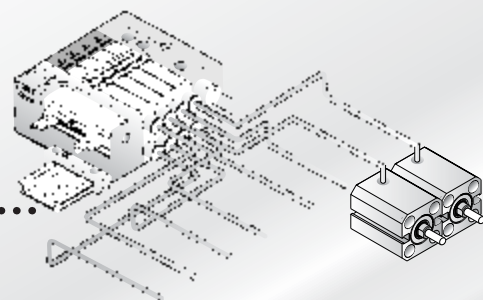

# MN<sup>3</sup>/<sub>4</sub>SO Series

## Ample variations

- Compatible with various reduced wiring methods
- Locking or non-locking equipped
- Selectable joint types
- Check valve integrated

## Compact and smart

Compact manifold saves space. The flat top face and integrated exhaust muffler provide a smart appearance.

## Mixed 3, 4 port valve usage

The 3 port and 4 port valves can be mixed within the same manifold.

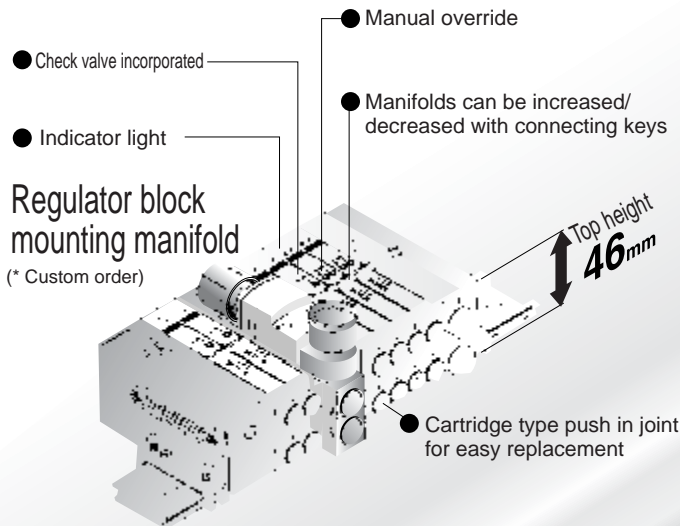

## Wiring method

- D sub-connector



- Flat cable connector



- Individual wiring connector

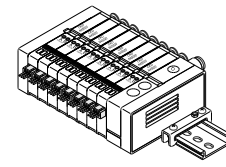

- Common gland

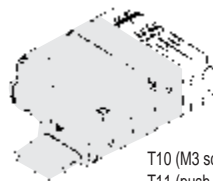

- Serial transmission



T10 (M3 screw): 14 points  
T11 (push-in fitting): 24 points

MN3E0  
MN4E0

4GA/B

M4GA/B

MN4GA/B

4GA/B  
(Master)

W4GA/B2

W4GB4

**MN3SO  
MN4SO**

4TB

4L2-4/  
LMF0

4SA/B0

4SA/B1

4KA/B

4F

PV5G/  
CMF

PV5/  
CMF

3MA/B0

3PA/B

P/M/B

NP/NAP/  
NVP

4F\*0E

HMV  
HSV

2QV  
3QV

SKH

PCD/  
FS/FD

Ending

Reduced wiring block manifold  
3, 4 port pilot operated valve

# Series variation

# MN3S0/MN4S0 Series

MN3E0
MN4E0
4GA/B
M4GA/B
MN4GA/B
4GA/B (Master)
W4GA/B2
W4GB4
<b>MN3S0</b>
<b>MN4S0</b>
4TB
4L2-4/LMFO
4SA/B0
4SA/B1
4KA/B
4F
PV5G/CMF
PV5/CMF
3MA/B0
3PA/B
P/M/B
NP/NAP/NVP
4F*0E
HMV/HSV
2QV/3QV
SKH
PCD/FS/FD
Ending

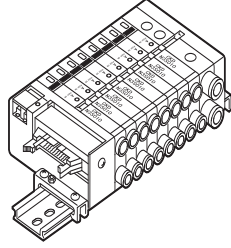
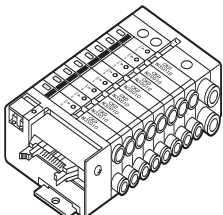
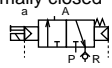
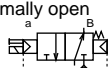
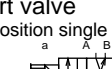
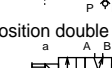
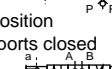
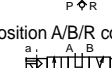
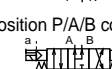
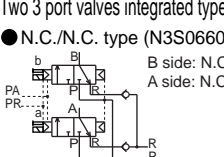
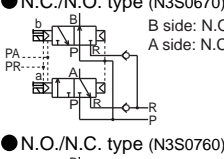
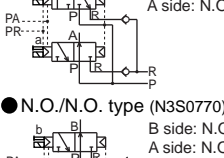
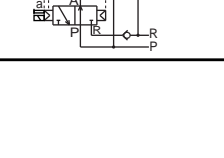
Appearance	Model no.	Position No. of solenoid JIS symbol	Valve performance		Voltage (V)							
			Flow characteristics C (dm <sup>3</sup> / (s·bar)) Note 1	Applicable cylinder bore size								
 	<b>MN3S0/MN4S0</b>	3 port	MN3S0	DIN rail Installation	3 port valve ● 2-position normally closed  ● 2-position normally open  4 port valve ● 2-position single solenoid  ● 2-position double solenoid  ● 3-position all ports closed  ● 3-position A/B/R connection  ● 3-position P/A/B connection 	0.57 to 0.80	ø 20 to ø 40	24 DC 12 DC				
		4 port	MN4S0									
	<b>MT3S0/MT4S0</b>	3 port	MT3S0	Direct mount (limited to 8 stations)								
		4 port	MT4S0									
	<b>MN3S0</b> Two 3 port valves integrated in a valve block.	<b>MN3S0</b>	3 port	MN3S0 DIN rail Installation					Two 3 port valves integrated type ● N.C./N.C. type (N3S0660)  ● N.C./N.O. type (N3S0670)  ● N.O./N.C. type (N3S0760)  ● N.O./N.O. type (N3S0770) 	0.50	ø20 or less	24 DC 12 DC

Note 1: Effective sectional area S and sonic conductance C are converted as  $S \approx 5.0 \times C$ .

\*Note 1: Effective sectional area S and sonic conductance C are converted as  $S \approx 5.0 \times C$ .

	Solenoid position											A/B port size			Wiring method					Page		
	3, 4 port valve						Two 3 port valves integrated type					Mix	Push-in joint		Female thread	Common gland	D sub-connector	Flat cable	Serial transmission		Individual wiring connector	
	2-position single solenoid	2-position double solenoid	3-position all ports closed	3-position A/B/R connection	3-position P/A/B connection	2-position single solenoid NC	2-position single solenoid NO	A side NC B side NC	A side NC B side NO	A side NO B side NC	A side NO B side NO		ø4	ø6								M5
						●	●					●	●	●	●	●	●	●	●	●	●	590
	●	●	●	●	●							●	●	●	●	●	●	●	●	●	●	590
						●	●					●	●	●	●	●	●	●			●	590
	●	●	●	●	●							●	●	●	●	●	●				●	590
								●	●	●	●	●	●	●	●	●	●	●	●	●	●	590
								●	●	●	●	●	●	●	●	●	●	●			●	590

Refer to the following page for details of wiring method and other options.

MN3E0  
MN4E0

4GA/B

M4GA/B

MN4GA/B

4GA/B  
(Master)

W4GA/B2

W4GB4

**MN3S0**  
**MN4S0**

4TB

4L2-4/  
LMF0

4SA/B0

4SA/B1

4KA/B

4F

PV5G/  
CMF

PV5/  
CMF

3MA/B0

3PA/B

P/M/B

NP/NAP/  
NVP

4F\*0E

HMV  
HSV

2QV  
3QV

SKH



PCD/  
FS/FD

Ending

Reduced wiring block manifold  
3, 4 port pilot operated valve

# MN3S0/MN4S0 Series

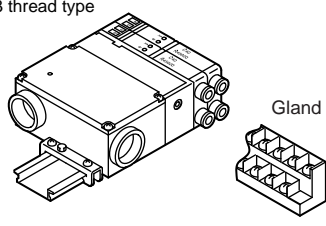
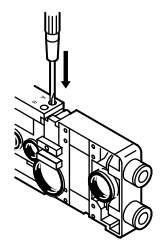
@

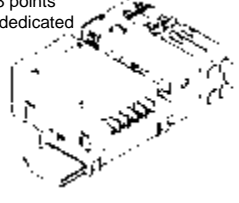
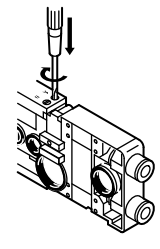
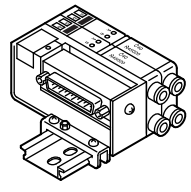
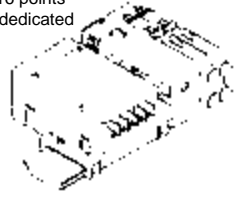
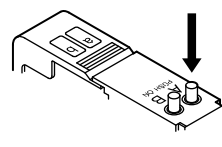
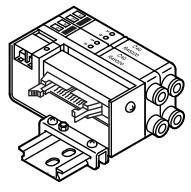
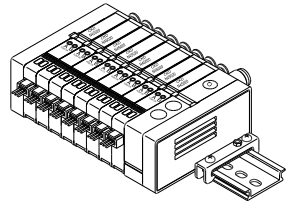
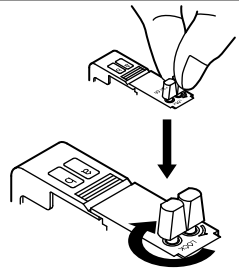
	Wiring method		Manual override
MN3E0 MN4E0			
4GA/B	T10 T10R	Common gland type (left side installation) Common gland type (right side installation)	T6G1 T6C1/0 T6E1/0
M4GA/B	<ul style="list-style-type: none"> <li>● Preparing common wiring</li> <li>● M3 thread type</li> </ul> 		Serial transmission type
MN4GA/B			Blank
4GA/B (Master)			Non-locking type
W4GA/B2			
W4GB4			
MN3S0 MN4S0	T11 T11R	Common gland type (left side installation) Common gland type (right side installation)	T6A0 T6J0
4TB	<ul style="list-style-type: none"> <li>● Preparing common wiring</li> <li>● Push tightening type</li> </ul> 		Serial transmission type and UNIWIRE
4L2-4/ LMF0			<ul style="list-style-type: none"> <li>● UNIWIRE SYSTEM (T6A0), UNIWIRE H SYSTEM (T6J0)</li> <li>● Output: 8 points</li> <li>● 24 VDC dedicated</li> </ul> 
4SA/B0			
4SA/B1			
4KA/B			
4F	T30 T30R	D sub-connector type (left side) D sub-connector type (right side)	T6A1 T6J1
PV5G/ CMF	<ul style="list-style-type: none"> <li>● Widely used in FA, OA components</li> <li>● Specified connector of RS232C standards</li> <li>● 25P, 24 VDC and 12 VDC dedicated</li> </ul> 		Serial transmission type and UNIWIRE
PV5/ CMF			<ul style="list-style-type: none"> <li>● UNIWIRE SYSTEM (T6A1), UNIWIRE H SYSTEM (T6J1)</li> <li>● Output: 16 points</li> <li>● 24 VDC dedicated</li> </ul> 
3MA/B0			
3PA/B			
P/M/B			
NP/NAP/ NVP	T50 T50R	Flat cable connector type (left side installation) Flat cable connector type (right side installation)	C
4F*0E	<ul style="list-style-type: none"> <li>● Widely used in FA, OA components</li> <li>● MIL standards (MIL-C-83503) conformed</li> <li>● 20P, 24 VDC and 12 VDC dedicated</li> </ul> 		With individual wiring connector and lead wire
HMV HSV			<ul style="list-style-type: none"> <li>● Lead wire length</li> <li>C : 300 mm</li> <li>C0 : 500 mm</li> <li>C1 : 1000 mm</li> <li>C2 : 2000 mm</li> </ul> 
2QV 3QV			
SKH			
PCD/ FS/FD			

## Surge suppressor / indicator light internal circuit diagram

\* Variable resistor is used for a surge suppressor.

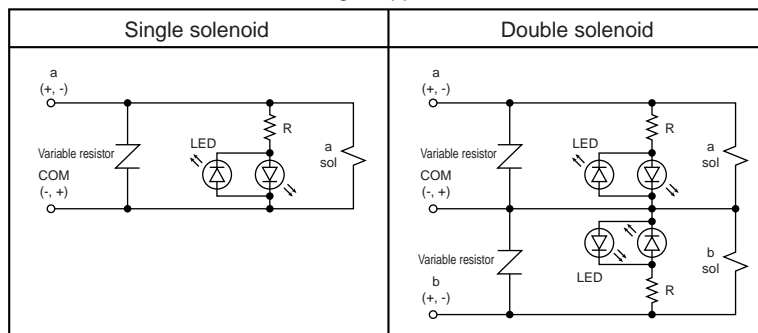



# Safety precautions

Always read this section before starting use.  
Refer to Intro 63 for valve general precautions.

PLC compatible reducer wiring 3, 4 port valve block manifold MN3S0/MN4S0 Series

## Design & Selection

### CAUTION

#### ■ Working air quality

- Use clean compressed air.  
(5 μ or less by using dryer, oil mist separator or air filter, etc.)  
This is to prevent accidents from occurring due to drainage, oil oxide, tar, foreign matter or rust in compressed air.
- Flush pipes before piping.
- This block manifold is used with oilless specifications as a standard.  
If lubrication is required, use Turbine Oil Class 1 ISOVG32 or equivalent. The solenoid valve could fail if a different type of oil is used, if lubrication is excessive, or if lubricant is not replenished after lubricating once.
- Use of ultra dry air could reduce life due to scattering of lubricant.
- The response time given in product specifications is the value when using with oilless specifications, at 0.5 MPa in energized state. An operation delay could occur if lubrication is excessive.

#### ■ Avoid using this product in the following environment.

- Where the ambient temperature exceeds 5 to 50 °C.
- Where product could be subject to water drops or cutting oil.
- Where there are high levels of dust.
- Environment containing salt air or corrosive gas.  
If the product must be used in this type of environment, provide protection with cover, etc.  
If used where subject to direct sunlight, the product could be discolored slightly by ultraviolet rays. However, this will not affect product performance.

## Installation & Adjustment

### 1. Installation

### CAUTION

- Avoid using this product where vibration is 50 m/s<sup>2</sup> and impact is 300 m/s<sup>2</sup> or more.  
Failure to observe this caused lead to malfunctions.
- Do not restrict air supply piping.  
Operation could be delayed by a temporary drop in the air supply pressure when manifolds operate simultaneously.
- Do not use the cylinder port released to air.  
Operation faults could occur due to a drop in air supply pressure, so use the external pilot operated type.  
(The lower limit pressure of the internal pilot operated type is 0.2 MPa.)
- Do not restrict the exhaust path.  
The cylinder's response could be delayed. Adjust the speed between the cylinder and valve.
- Do not seal the pilot exhaust path.  
Operation faults could occur if the pilot exhaust path is sealed, so provide an exhaust path.
- When braking the cylinder with 3-position all ports closed (N4S030), check that there are no leaks from piping connection and no internal leaks in the cylinder.  
(Use a cylinder with brake when long-term holding and a stopping accuracy are required.)

- Avoid installing this product in a place with poor ventilation and heat radiation.  
The surface temperature of the manifold will rise when continuously energized, but this is not problem. Check that the ambient temperature does not exceed 50 °C.

- When using the two 3 port valves integrated type, check that the main pressure in the manifold does not drop below the minimum working pressure due to the various pressure control method, and avoid using with the valve block released to air.

### 2. Applicable piping tube

### CAUTION

- Observe the following precautions when using nylon tubes or urethane tubes for piping material.
  - Use a flame resistance tube or steel pipe when using in an environment where spatter could scatter.
  - Use a hydraulic hose for piping to be used for both hydraulics and pneumatics.  
When using the standard push-in joint on the spiral tube, fix the base of the tube with a hose band. The tube could rotate and reduce holding performance.  
Use a tightened joint when using in a high ambient temperature. The push-in joint can not be used.

MN3E0  
MN4E0

4GA/B

M4GA/B

MN4GA/B

4GA/B  
(Master)

W4GA/B2

W4GB4

MN3S0  
MN4S0

4TB

4L2-4/  
LMF0

4SA/B0

4SA/B1

4KA/B

4F

PV5G/  
CMFPV5/  
CMF

3MA/B0

3PA/B

P/M/B

NP/NAP/  
NVP

4F\*0E

HMV  
HSV2QV  
3QV

SKH

PCD/  
FS/FD

Ending

Reduced wiring block manifold  
3, 4 port pilot operated valve



# MN3S0/MN4S0 Series

## Precautions

### ⚠ CAUTION

#### ■ Connecting piping

- Applicable tube  
When using a solenoid valve with push-in joint, use the CKD designated tube.

Soft nylon (F-1500 Series)  
Urethane (U-9500 Series)

When using a commercially available tube, check dimensions accuracy, thickness, and hardness. Use a urethane tube with a hardness of 93° over (rubber hardness meter). If a tube that does not satisfy the diameter accuracy or hardness is used, the chucking force may drop, the tube may dislocate, or may be difficult to insert.

#### Tube dimension

	Outer diameter mm	Inner diameter mm	
		Nylon	Urethane
4TB	ø4	ø2.5	ø2
4L2-4/LMFO	ø6	ø4	ø4
4SA/B0	ø8	ø5.7	ø5
	ø10	ø7.2	ø6.5
	ø12	ø8.9	ø8

#### Tolerance of outer diameter

Soft/hard nylon	±0.1 mm
Urethane ø4, ø6	+0.1 mm
	-0.15 mm
ø8, ø10, ø12,	+0.1 mm
	-0.2 mm

#### ● Tube bending radius

The tube's bending radius must be larger than the min. bending radius. (Failure to observe this can lead to dislocation or leaks.)

Bore size	Minimum bending radius mm	
	Nylon	Urethane
ø4	10	10
ø6	20	20
ø8	30	30
ø10	40	40
ø12	55	50

#### ● Cutting the tube

Always use a tube cutter (AZ1200), and cut at a right angle in the axial direction. Air could leak if a tube cut at a slant is inserted.

#### ● State of tube connection

Provide a straight section as long as the O.D. of the tube being used from the end of the joint, and avoid piping with a sudden bending at the joint insertion port. Check that the tube's tensile strength in the lateral direction does not exceed 40 N.

#### ● Applicable blanking plug

When using the solenoid valve with push-in joint, use the CKD designated blanking plug.  
Blanking plug GZP\*-B Series

## 3. Power supply circuit and connection

### ⚠ CAUTION

- Check that leakage current from the programmable controller is less than 1 mA at the circuit.  
The valve could malfunction if the leakage current is high.
- The instantaneous energizing operation of the double solenoid type must be at least 0.1 second over.
- Refer to the instruction manual when replacing or extending blocks. Pay attention to the order of connecting cable connector.
- Refer to precautions for wiring for details on other wire connections.
- If the valve block may be expanded in the future, indicate the spare cable in manifold specifications. (Note that up to 4 cables can be connected to 1 air supply/exhaust)

## 4. Manual override

### ⚠ CAUTION

- The MN4S0 is manually operated with an indirect drive method using pilot pressure.  
The valve will not operate unless pilot pressure is supplied.

#### (1) Non-locking type

- Press the button on the top of the valve with a thin tool (ø2 or less), until it is completely pressed. Pressing A will be the same as when the a coil operates, and pressing B will be the same as when the b coil operates.
- When the single or 3-position type is released, the main valve will also return. With the double type, the button will return, but the main valve will be held at that position.

#### (2) Locking type

- In addition to non-locking type functions, when the button is pressed and turned 90 degrees in the direction of the arrow (using a 2 mm precision flat-tip screwdriver), the state can be held.

Release the lock before starting normal operation.

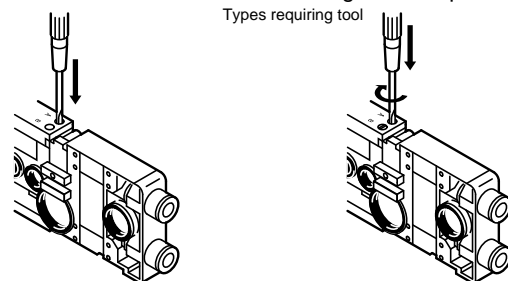

● Non-locking

● Locking

When using the custom order non-locking type or locking type that does not require a tool, provide a cover when not in use to ensure safety.

### During Use & Maintenance

#### 1. Surge suppressor

##### ⚠ CAUTION

■ The surge suppressor enclosed with the solenoid valve is to protect the output contact for that solenoid valve's drive. There is no significant protection for the other peripheral devices, and devices could be damaged or malfunction by the surge. Surge generated by other devices could be absorbed and cause damage such as burning. Care must be taken for points below.

- (1) The surge suppressor limits solenoid valve surge voltage, which can reach several hundred volts, to a lower voltage level withstandable by the output contact. Depending on the output circuit used, this may be insufficient and could result in damage or malfunction. Check whether the surge suppressor can be used by the surge voltage limit of the solenoid valve in use, the output device's withstand pressure and circuit structure, and by the degree of return delay time. If necessary, provide other surge measures. Solenoid valves with surge suppressors suppress the reverse voltage surge generated during OFF operation to the levels below.

Rated voltage	Reverse voltage value when power turned OFF
12 VDC	27 V
24 VDC	47 V

- (2) When using the NPN output unit, a surge voltage equivalent to the voltage above plus the power voltage surge could be applied. Provide contact protection circuit.

(Example of output transistor protective circuit installation 1)

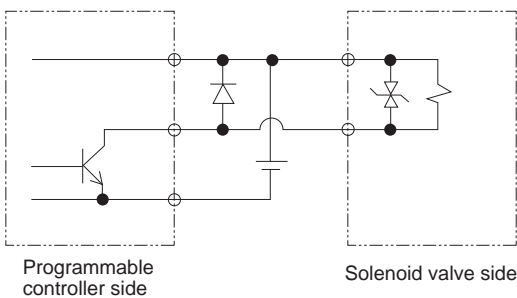

(Example of output transistor protective circuit installation 2)

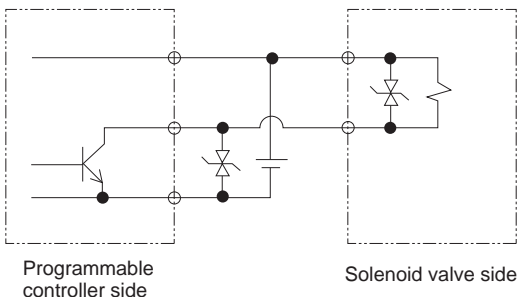

- (3) If another device or solenoid valve is connected in parallel to the solenoid valve, reverse voltage surge generated during the solenoid valve is off is applied to these devices. Even when using the solenoid valve with surge suppressor for 24 VDC, the surge voltage may reach minus several ten V depending on the model. This inverse polarity voltage could damage or cause the other devices connected in parallel to malfunction. Avoid parallel connection of devices suspected of reversing polarity voltages, e.g., LED indicators. When driving several solenoid valves in parallel, the surge from other solenoid valves could enter the surge suppressor of one solenoid valve with a surge suppressor. Depending on the current value, that surge suppressor could burn. When driving several solenoid valves with surge suppressors in parallel, surge current could concentrate at the surge suppressor with the lowest limit voltage and cause similar burning. Even if the solenoid valve type is the same, the surge suppressor's limit voltage can be inconsistent, and in the worst case, could result in burning. Avoid driving several solenoid valves in parallel.
- (4) The surge suppressor incorporated in the solenoid valve often short-circuits if damaged by excessive voltage or current the other solenoid valves. If the surge suppressor fails, if a large current flows when output is on, the output circuit or solenoid valve could be damaged or ignite. Do not keep power on in a faulty state. Provide an overcurrent protection circuit on the power or drive circuit or use a power supply with overcurrent protection so that a large current does not flow continuously.

#### 2. Assembling & Disassembling

##### ⚠ CAUTION

■ Turn power OFF and depressurize before starting following work:

- Refer to technical data (page 615) for details on expansion, disassembly, and assembly required when changing the regulator body or regulator block specifications or when replacing a spent regulator. Consult with CKD for details.
- After assembly, confirm that the joint's stop pin is accurately assembled between the connection key and regulator block. Refer to the MN4S0 Instruction Manual for details on handling the valve block.

MN3E0
MN4E0
4GA/B
M4GA/B
MN4GA/B
4GA/B (Master)
W4GA/B2
W4GB4
MN3S0
MN4S0
4TB
4L2-4/LMF0
4SA/B0
4SA/B1
4KA/B
4F
PV5G/CMF
PV5/CMF
3MA/B0
3PA/B
P/M/B
NP/NAP/NVP
4F*0E
HMV/HSV
2QV/3QV
SKH
PCD/FS/FD
Ending

Reduced wiring block manifold  
3, 4 port pilot operated valve



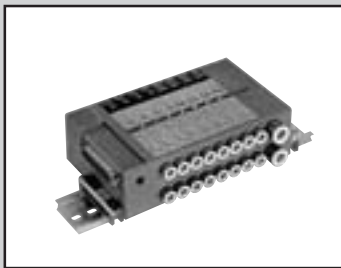

# Reduced wiring block manifold 3, 4 port pilot operated valve **MN3S0/MN4S0** series

● Applicable cylinder bore size:  $\varnothing 20$  to  $\varnothing 40$



Refer to Intro 17 for details.



## JIS Symbol

● 3 port valve  
2-position single solenoid N.C. type

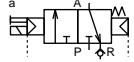

2-position single solenoid N.O. type

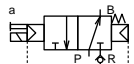

● 4 port valve  
2-position single solenoid

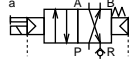

2-position double solenoid

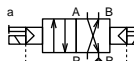

3-position all ports closed

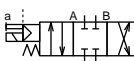

3-position A/B/R connection

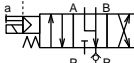

3-position P/A/B connection



● Two 3 port valves integrated type  
N.C./N.C. type (N3S0660)

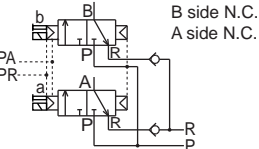

N.C./N.O. type (N3S0670)

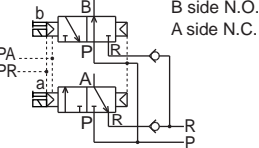

N.O./N.C. type (N3S0760)

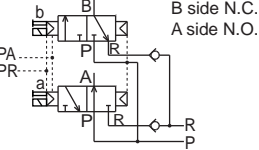

N.O./N.O. type (N3S0770)

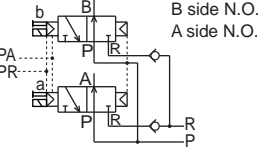

## Common specifications

Descriptions	Descriptions
Manifold method	DIN Rail mount Direct mount (8 limited to stations)
Manifold type	Common supply, Common exhaust
Station quantity	From 1 station (refer to the following page.)
Valve and operation type	Internal pilot operated soft spool valve
Working fluid	Compressed air
Max. working pressure MPa	0.70
Min. working pressure MPa	0.20 (When external pilot, main pressure 0)
Withstanding pressure MPa	1.05
Ambient temperature °C	5 to 50
Fluid temperature °C	5 to 50
Lubrication	Not required
Protective structure	Dust proof
Vibration/impact m/s <sup>2</sup>	50 or less / 300
Working environment	Containing corrosive gas is impermissible.

## Individual specifications

Port		3 port valve	4 port valve	Note 2 3 port valve 2 piece integrated type
Port size	A/B Port	$\varnothing 4, \varnothing 6$ push-in joint, M5	$\varnothing 4, \varnothing 6$ push-in joint, M5	$\varnothing 4, \varnothing 6$ push-in joint, M5
	P/R Port	$\varnothing 8, \varnothing 6$ push-in joint	$\varnothing 8, \varnothing 6$ push-in joint	$\varnothing 8, \varnothing 6$ push-in joint
	External pilot port	$\varnothing 6$ push-in joint	$\varnothing 6$ push-in joint	-
Response time Note 1 ms	2-position	20 or less	20 or less	20 or less
	3-position	-	30 or less	-

Note 1: Response time is the value when ON for supply pressure 0.5 MPa, pre-lubricated. The value varies depending on pressure and quality of lubricant.  
Note 2: For two 3 port valve integrated valve block, external pilot is not available because main pressure is used to operate valving element. Supply enough air flow rate not to drop supply pressure less than minimum working pressure by driving connecting load (air operated valve) etc.

## Flow characteristics

Descriptions		C (dm <sup>3</sup> / (s·bar))	b
3 port valve	2-position	0.80	0.33
	2-position	0.80	0.33
4 port valve	3-position	all ports closed	0.31
		A/B/R connection	0.80
		P/A/B connection	0.60
Two 3 port valves integrated type	2-position	0.50	0.17

Note 1: Effective sectional area S and sonic conductance C are converted as  $S \approx 5.0 \times C$ .  
Note 2: The flow characteristics are the values with check valve (standard).

## Ozone specifications (Ending 5)

\*\* - Voltage - P11

### Slave unit specifications

Descriptions	T6C1 T6C0	Note 1 T6G1	T6A1 T6A0	T6J1 T6J0	T6E1 T6E0
	Unit side power voltage	24 VDC ± 10%		24 VDC	
Valve side power voltage	24 VDC +10% -5%		+10% -5%		
Unit side current consumption	T6C1: 60mA or less, T6C0: 40mA or less (when all outputs ON)	100mA or less (when all outputs ON)	100 mA or less (when all outputs ON. Current consumption of valve not included)		60 mA or less (when all outputs ON. Current consumption of valve not included)
Valve side current consumption	15mA or less (All points OFF)				
Output no.	T6C1: 16 points T6C0: 8 points	16 points	T6A1: 16 points T6A0: 8 points	T6J1: 16 points T6J0: 8 points	T6E1: 16 points T6E0: 8 points

Note 1: CC-Link is Ver.1.10.

### Manifold wiring specifications Note1

Descriptions	Descriptions	Max. station number			
		Double solenoid	Single solenoid	Mix manifold (solenoid number)	
Common gland type	T10(Left) T10R(Right)	Terminal thread M3	7 stations	14 stations	14 points
	T11(Left) T11R(Right)	26 pole push tightening type	12 stations	24 stations	24 points
	T30(Left) T30R(Right)	MIL standards D sub-connector (Terminal number 25)	12 stations	24 stations	24 points
	T50(Left) T50R(Right)	Pressure welding connector MIL-C-83503 standards conformed Flat cable 1.27 mm pitch 20 pieces	8 stations	16 stations	16 points
Serial transmission type (With dedicated unit)	T6A0	UNIWIRES SYSTEM	4 stations	8 stations	8 points
	T6A1		8 stations	16 stations	16 points
	T6C0	OMRON	4 stations	8 stations	8 points
	T6C1	CompoBus/S	8 stations	16 stations	16 points
	T6E0	SUNX	4 stations	8 stations	8 points
	T6E1	S-LINK	8 stations	16 stations	16 points
	T6G1	CC-Link	8 stations	16 stations	16 points
	T6J0 T6J1	UNIWIRES H SYSTEM	4 stations 8 stations	8 stations 16 stations	8 points 16 points
Individual wiring connector type (Double is common)	C	Individual connector lead wire length 300 mm	-	-	-
	C0	Individual connector lead wire length 500 mm	-	-	-
	C1	Individual connector lead wire length 1000 mm	-	-	-
	C2	Individual connector lead wire length 2000 mm	-	-	-

Note 1 Contact CKD if more manifold stations than the max. number of stations for each reduced-wiring specification are required.

### Weight

Wiring block	Descriptions	Common gland type T10 (R) / T11 (R)	D sub-connector type T30 (R)	Flat cable connector type T50 (R)	Serial transmission type T6*	
		Weight (g)	175	85	85	220
Supply/exhaust block	Descriptions	Q	QK	QZ	QKZ	
	Weight (g)	48	53	48	60	
Partition block	Descriptions	S	SA	SP	SE	
	Weight (g)	20	20	20	20	
Valve block	Descriptions	N4S010	N4S020	N4S030/040/050	N3S010/110	N3S0**0
	Weight (g)	50	55	58	46	55
End block	Descriptions	E (EL)	EX (EXL)			
	Weight (g)	50	50			
DIN rail	Descriptions	-				
	Weight (g)	0.9 g/mm				

MN3E0  
MN4E0

4GA/B

M4GA/B

MN4GA/B

4GA/B  
(Master)

W4GA/B2

W4GB4

MN3S0  
MN4S0

4TB

4L2-4/  
LMF0

4SA/B0

4SA/B1

4KA/B

4F

PV5G/  
CMF

PV5/  
CMF

3MA/B0

3PA/B

P/M/B

NP/NAP/  
NVP

4F\*0E

HMV  
HSV

2QV  
3QV

SKH

PCD/  
FS/FD

Ending

Reduced wiring block manifold  
3, 4 port pilot operated valve

# MN3S0/MN4S0 Series

How to order manifold

D sub / flat cable connector / individual wiring C-connector

- MN3E0
- MN4E0
- 4GA/B
- M4GA/B
- MN4GA/B
- 4GA/B (Master)
- W4GA/B2
- W4GB4
- MN3S0
- MN4S0
- 4TB
- 4L2-4/LMFO
- 4SA/B0
- 4SA/B1
- 4KA/B
- 4F
- PV5G/CMF
- PV5/CMF
- 3MA/B0
- 3PA/B
- P/M/B
- NP/NAP/NVP
- 4F\*0E
- HMV
- HSV
- 2QV
- 3QV
- SKH
- PCD/FS/FD
- Ending

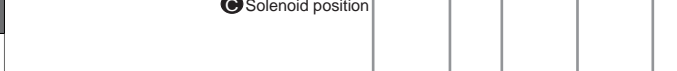
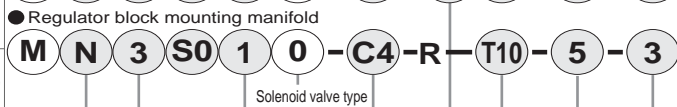
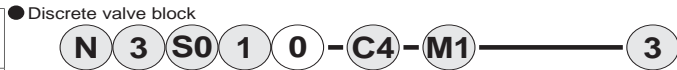

Note 1: Complete manifold specification sheet (pages 618 to 620).

Consult with CKD when ordering regulator block mounting manifold. (Technical confirmation No. is required.)

Type	
Block manifold	Discrete valve block

Technical confirmation No.	Symbol	Descriptions	Block manifold	Discrete valve block
<b>A Model</b>				
	N	DIN rail mount method	●	
	T	Direct mount method (limited to valve block 8 stations)	●	
<b>B Valve type</b>				
	3	3 port valve, two 3 port valves integrated type Note 2	●	●
	4	4 port valve, 3, 4 ports valve mix	●	●
<b>C Solenoid position</b>				
	1	2-position normally closed single	●	●
	11	2-position normally open single	●	●
	66	A side valve Normally closed	●	●
		B side valve Normally closed	●	●
	67	A side valve Normally closed	●	●
		B side valve Normally open	●	●
	76	A side valve Normally open	●	●
		B side valve Normally closed	●	●
	77	A side valve Normally open	●	●
		B side valve Normally open	●	●
	1	2-position single solenoid	●	●
		2-position double solenoid	●	●
		3-position all ports closed	●	●
		3-position A/B/R connection	●	●
		3-position P/A/B connection	●	●
	8	Mix manifold	●	
<b>D Port size</b>				
	C4	ø4 push-in joint lateral	●	●
	C6	ø6 push-in joint lateral	●	●
	CL4	ø4 push-in joint upward	●	●
	CL6	ø6 push-in joint upward	●	●
	M5	M5 female thread (non-rotating)	●	●
	CX	Mix push-in joint	●	
<b>E Manual override</b>				
	Blank	Non-locking manual override	Standard	●
	M1	Locking manual override (tool required)	Option	●
	M2	Non-locking convex type	Custom order	●
	M3	Locking convex type		●
	MX	Mix of manual override		●
<b>F Wiring method</b>				
	T10	Common gland (M3 screw) type Left	●	
	T11	Common gland (push-in fitting) type Left	●	
	T30	D sub-connector type (25P) Left	●	
	T50	Flat cable connector type (20P) Left	●	
	T10R	Common gland (M3 screw) type Right	●	
	T11R	Common gland (push-in fitting) type Right	●	
	T30R	D sub-connector type (25P) Right	●	
	T50R	Flat cable connector type (20P) Right	●	
	C	Individual wiring connector with lead wire length 300 mm	●	●
	C0	Individual wiring connector with lead wire length 500 mm	●	●
	C1	Individual wiring connector with lead wire length 1000 mm	●	●
	C2	Individual wiring connector with lead wire length 2000 mm	●	●
<b>G Station number</b>				
	1	1 station	Differs based on wiring specifications. Refer to wiring specifications (page 591)	●
	to	to		
	24	24 stations		
	8	Direct mount method		●
<b>H Voltage</b>				
	3	24 VDC	●	●
	4	12 VDC	●	●

## Note on model no. selection

- Note 2: Consult with CKD about working conditions of two 3 port valves integrated type valve block.
- Note 3: For A/B port with filter (foreign matter mixture prevention), indicate F after port size symbol. (Option)
- Note 4: Wiring methods of direct mount method for T10, T11, T30, T50.
- Note 5: The dedicating cable is required to connect between wiring block and valve block of reduced wiring type. If the block will be expanded or specifications will be changed, when placing order, indicate reserve cable. (When standard wire, 2 expansion cable are initially attached.)

## <Example of model number>

**MN3S0660-C4-T10-6-3**

Block manifold

- A Model : DIN rail mount method
- B Valve type : Two 3 port valves integrated type
- C Solenoid position : A side valve: Normally closed  
B side valve: Normally closed
- D Port size : ø4 push-in joint lateral (cylinder port)
- E Manual override : Non-locking manual override
- F Wiring method : Common gland (M3 screw) type
- G Manifold solenoid valve station number : 6 stations
- H Voltage : 24 VDC

Manifold solenoid valve station number

Voltage

### How to order manifold

### Serial transmission

● Discrete valve block



● Block manifold



● Regulator block mounting manifold

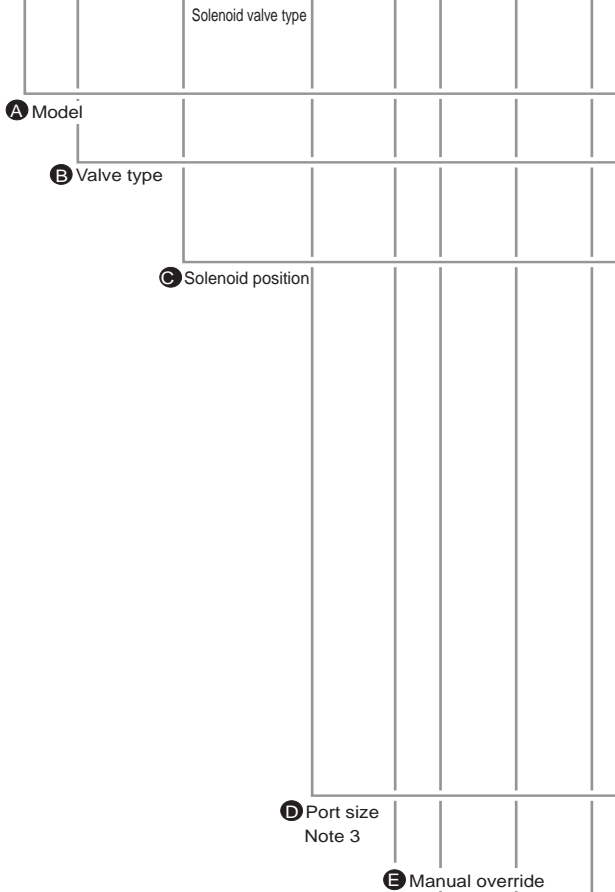
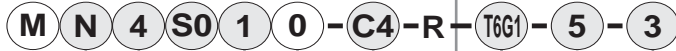

Note 1: Complete manifold specification sheet (pages 618 to 620).

Symbol		Descriptions	Type	
			Block manifold	Discrete valve block
<b>A Model</b>				
N	DIN rail mount method		●	
<b>B Valve type</b>				
3	3 port valve, two 3 port valves integrated type Note 2		●	●
4	4 port valve, 3, 4 ports valve mix		●	●
<b>C Solenoid position</b>				
1	2-position normally closed single		●	●
11	2-position normally open single		●	●
66	A side valve	Normally closed	●	●
	B side valve	Normally closed	●	●
67	A side valve	Normally closed	●	●
	B side valve	Normally open	●	●
76	A side valve	Normally open	●	●
	B side valve	Normally closed	●	●
77	A side valve	Normally open	●	●
	B side valve	Normally open	●	●
1	2-position single solenoid		●	●
2	2-position double solenoid		●	●
3	3-position all ports closed		●	●
4	3-position A/B/R connection		●	●
5	3-position P/A/B connection		●	●
8	Mix manifold		●	
<b>D Port size</b>				
C4	ø4 push-in joint lateral		●	●
C6	ø6 push-in joint lateral		●	●
CL4	ø4 push-in joint upward		●	●
CL6	ø6 push-in joint upward		●	●
M5	M5 female thread (non-rotating)		●	●
CX	Mix push-in joint		●	
<b>E Manual override</b>				
Blank	Non-locking manual override	Standard	●	●
M1	Locking manual override (tool required)	Option	●	●
M2	Non-locking convex type	Custom order	●	●
M3	Locking convex type		●	●
MX	Mix of manual override		●	
<b>F Wiring method</b>				
T6A0	Serial transmission type (UNIWIRE SYSTEM 8 points)		●	
T6A1	Serial transmission type (UNIWIRE SYSTEM 16 points)		●	
T6C0	Serial transmission type (OMRON: CompoBus/S 8 points)		●	
T6C1	Serial transmission type (OMRON: CompoBus/S 16 points)		●	
T6E0	Serial transmission type (SUNX: S-LINK 8 points)		●	
T6E1	Serial transmission type (SUNX: S-LINK 16 points)		●	
T6G1	Serial transmission type (CC-Link 16 points)		●	
T6J0	Serial transmission type (UNIWIRE H SYSTEM 8 points)		●	
T6J1	Serial transmission type (UNIWIRE H SYSTEM 16 points)		●	
<b>G Station number</b>				
1 to 16	1 station to 16 stations (Differs based on wiring specifications. Refer to wiring specifications (page 591))		●	
<b>H Voltage</b>				
3	24 VDC		●	●

### Note on model no. selection

Note 2: Consult with CKD about working conditions of two 3 port valves integrated type valve block.

Note 3: For A/B port with filter (foreign matter mixture prevention), indicate F after port size symbol. (Option)

Note 4: The dedicating cable is required to connect between wiring block and valve block of reduced wiring type. If the block will be expanded or specifications will be changed, when placing order, indicate reserve cable. (When standard wire, 2 expansion cable are initially attached.)

### <Example of model number>

**MN3S010-C4-T6G1-6-3**

Block manifold

- A** Model: DIN rail mount method
- B** Valve type : 3 Port valve
- C** Solenoid position : 2-position normally closed Single
- D** Port size : ø 4 push-in joint lateral (Cylinder port)
- E** Manual override : Non-locking manual override
- F** Wiring method : Serial transmission type (CC-Link 16 points)
- G** Manifold solenoid valve station number: 6 stations
- H** Voltage : 24 VDC

**G** Manifold solenoid valve station number

**H** Voltage

MN3E0  
MN4E0

4GA/B

M4GA/B

MN4GA/B

4GA/B (Master)

W4GA/B2

W4GB4

**MN3S0  
MN4S0**

4TB

4L2-4/  
LMF0

4SA/B0

4SA/B1

4KA/B

4F

PV5G/  
CMF

PV5/  
CMF

3MA/B0

3PA/B

P/M/B

NP/NAP/  
NVP

4F\*0E

HMV  
HSV

2QV  
3QV

SKH

PCD/  
FS/FD

Ending

Reduced wiring block manifold  
3, 4 port pilot operated valve

# MN3S0/MN4S0 Series

Reduced wiring block manifold (valve block): Two 3 port valves integrated type

MN3E0
MN4E0
4GA/B
M4GA/B
MN4GA/B
4GA/B (Master)
W4GA/B2
W4GB4
MN3S0
MN4S0
4TB
4L2-4/LMF0
4SA/B0
4SA/B1
4KA/B
4F
PV5G/CMF
PV5/CMF
3MA/B0
3PA/B
P/M/B
NP/NAP/NVP
4F*0E
HMV
HSV
2QV
3QV
SKH
PCD/FS/FD
Ending

## Internal structure and parts list

### N3S0660

● (Two 3 port valves integrated type N.C./N.C. type)

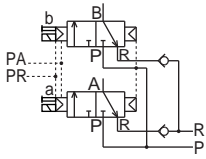

B side N.C.

A side N.C.

### N3S0670

● (Two 3 port valves integrated type N.C./N.O. type)

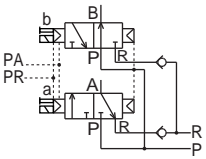

B side N.O.

A side N.C.

### N3S0760

● (Two 3 port valves integrated type N.O./N.C. type)

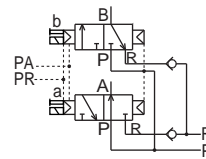

B side N.C.

A side N.O.

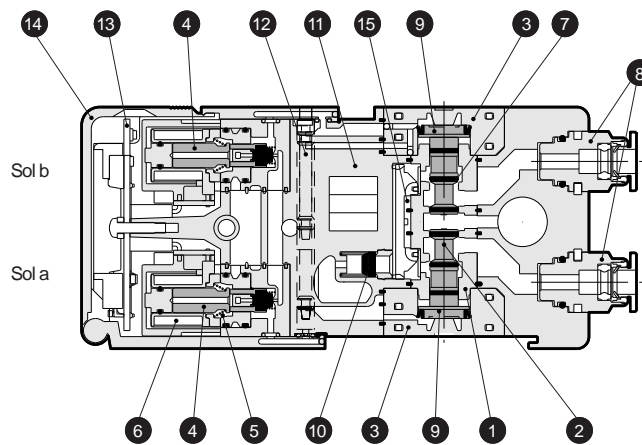

This drawing shows the two 3 port valves integrated N.C./N.C. type with the solenoids on both ends OFF.

### N3S0770

● (Two 3 port valves integrated type N.O./N.O. type)

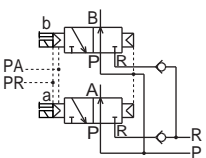

B side N.O.

A side N.O.

## Main parts list

No.	Parts name	Material	No.	Parts name	Material
1	Body	Aluminum alloy	9	Piston D assembly	-
2	Valving element (spool)	Aluminum, nitrile rubber	10	Check valve	-
3	Cap	-	11	Pilot block	Resin
4	Plunger	Stainless steel	12	Manual override	Aluminum
5	Plunger spring	Stainless steel wire	13	Circuit board assembly	-
6	Coil assembly	-	14	Electric cover	Polycarbonate
7	Spool packing seal	Nitrile rubber	15	Lead valve assembly	-
8	Cartridge type push-in joint	-			

### Internal structure and parts list

#### N3S010

● 2-position single solenoid normally closed

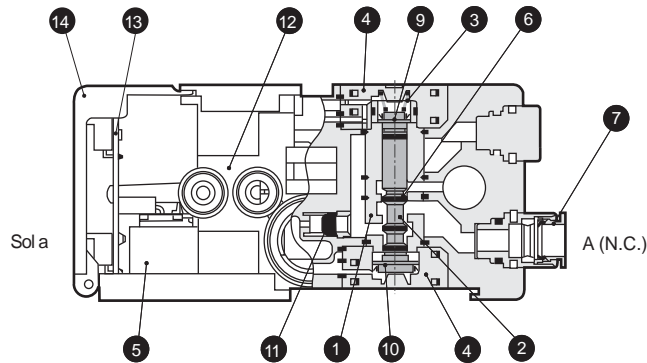
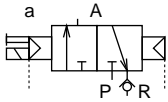

#### N3S0110

● 2-position single solenoid normally open

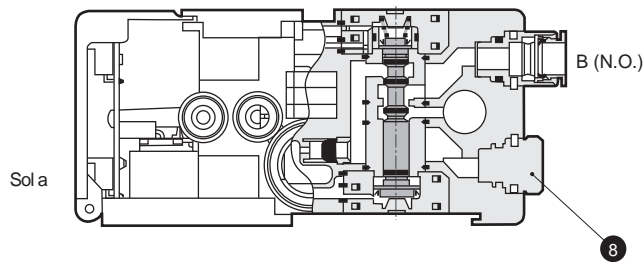
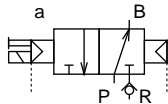

MN3E0
MN4E0
4GA/B
M4GA/B
MN4GA/B
4GA/B (Master)
W4GA/B2
W4GB4
<b>MN3S0</b>
<b>MN4S0</b>
4TB
4L2-4/LMF0
4SA/B0
4SA/B1
4KA/B
4F
PV5G/CMF
PV5/CMF
3MA/B0
3PA/B
P/M/B
NP/NAP/NVP
4F*0E
HMV
HSV
2QV
3QV
SKH
PCD/FS/FD
Ending

### Main parts list

No.	Parts name	Material	No.	Parts name	Material
1	Body	Aluminum alloy	9	Piston S assembly	-
2	Valving element (spool)	Aluminum alloy	10	Piston D assembly	-
3	Valve spring	-	11	Check valve	-
4	Cap	-	12	Pilot block	Resin
5	Coil assembly	-	13	Circuit board assembly	-
6	Spool packing seal	Nitrile rubber	14	Electric cover	Polycarbonate
7	Cartridge type push-in joint	-			
8	Plug cartridge	-			

Reduced wiring block manifold  
3, 4 port pilot operated valve



# MN3S0/MN4S0 Series

Reduced wiring block manifold (valve block): 4 port valve

## Internal structure and parts list

### N4S010

● 2-position single solenoid

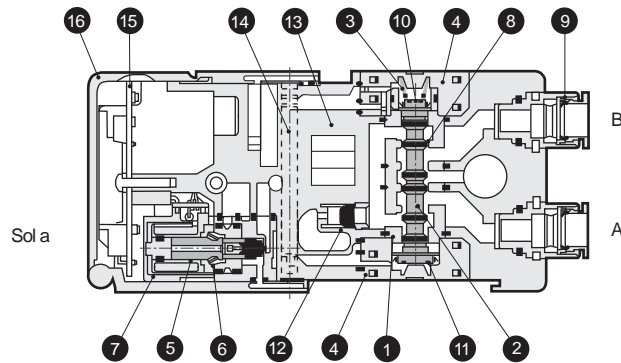
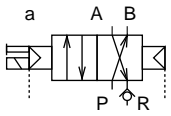

### N4S020

● 2-position double solenoid

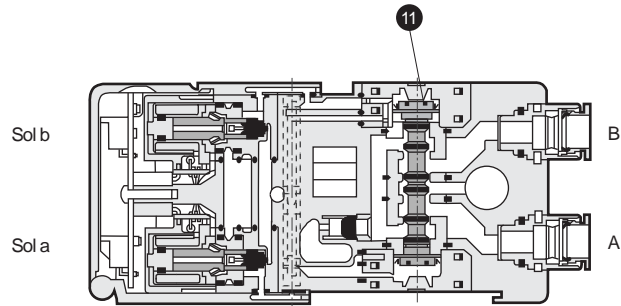
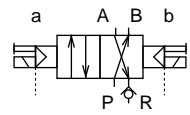

### N4S030

● 3-position all ports closed

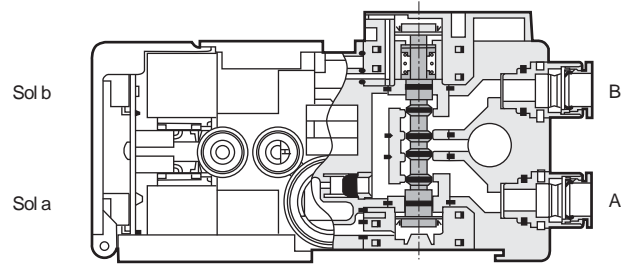
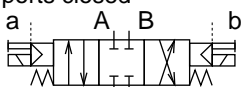

### N4S040

● 3-position A/B/R connection

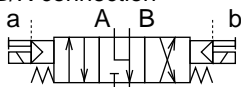

### N4S050

● 3-position P/A/B connection

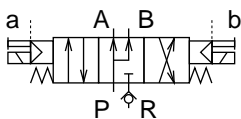

This drawing shows the state with the all ports closed OFF.

## Main parts list

No.	Parts name	Material	No.	Parts name	Material
1	Body	Aluminum alloy	9	Cartridge type push-in joint	-
2	Valving element (spool)	Aluminum alloy	10	Piston S assembly	-
3	Valve spring	-	11	Piston D assembly	-
4	Cap	-	12	Check valve	-
5	Plunger	Stainless steel	13	Pilot block	Resin
6	Plunger spring	Stainless steel wire	14	Manual override	Aluminum
7	Coil assembly	-	15	Circuit board assembly	-
8	Spool packing seal	Nitrile rubber	16	Electric cover	Polycarbonate

### Internal structure and parts list

#### N4S0-Q

● Supply and exhaust block (internal pilot)

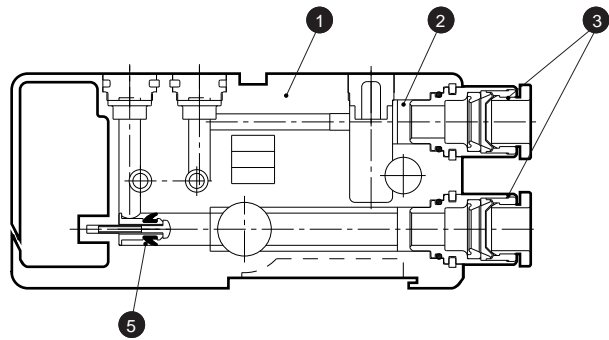
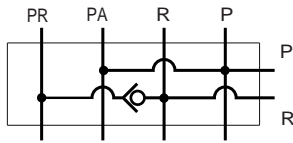

#### N4S0-QK

● Supply and exhaust block (external pilot)

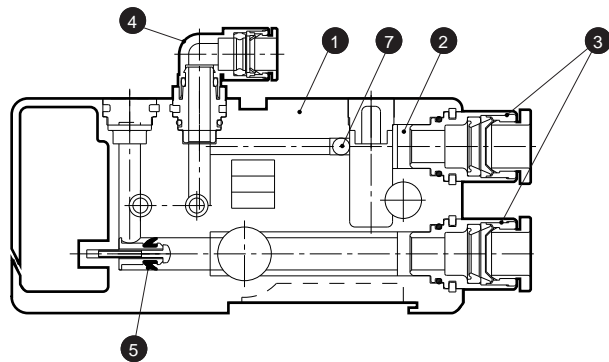
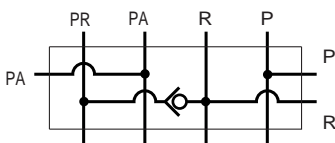

#### N4S0-QZ

● Supply and exhaust block (multi-pressure circuit)

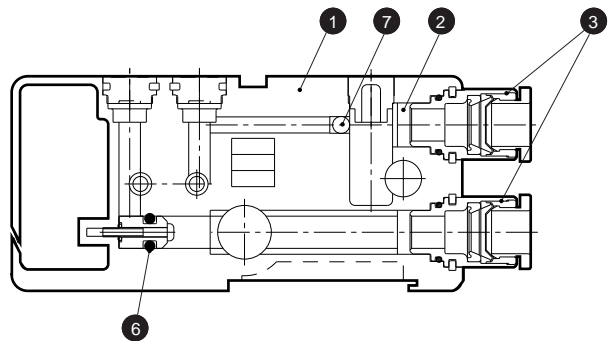
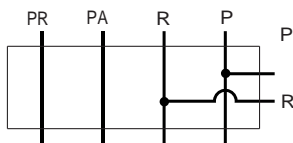

#### N4S0-QKZ

● Supply and exhaust block (PA/PR separate type for external pilot)

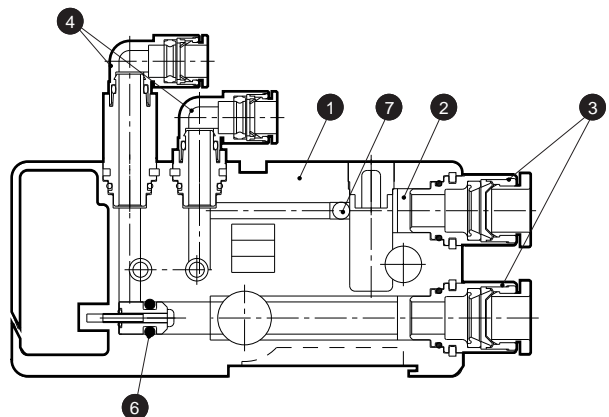
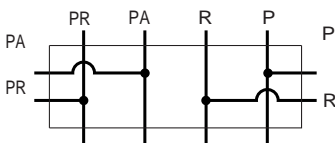

### Main parts list

No.	Parts name	Material	No.	Parts name	Material
1	Supply and exhaust block	Resin	5	Check valve	-
2	Filter	-	6	R/PR separation plug	-
3	Cartridge type push-in joint (main piping section)	-	7	Stainless steel ball	-
4	Cartridge type push-in joint (external pilot piping)	-			

MN3E0  
MN4E0

4GA/B

M4GA/B

MN4GA/B

4GA/B  
(Master)

W4GA/B2

W4GB4

**MN3S0**  
**MN4S0**

4TB

4L2-4/  
LMF0

4SA/B0

4SA/B1

4KA/B

4F

PV5G/  
CMF

PV5/  
CMF

3MA/B0

3PA/B

P/M/B

NP/NAP/  
NVP

4F\*0E

HMV  
HSV

2QV  
3QV

SKH

PCD/  
FS/FD

Ending

Reduced wiring block manifold  
3, 4 port pilot operated valve

# MN3S0/MN4S0 Series

Reduced wiring block manifold: DIN rail mount

Dimensions



**MN<sub>4</sub>S0\*0-\*\*-\*T6\*\*-\*\*-\***

● Serial transmission type: (T6A0/1, T6C0/1, T6E0/1, T6G1, T6J0/1)

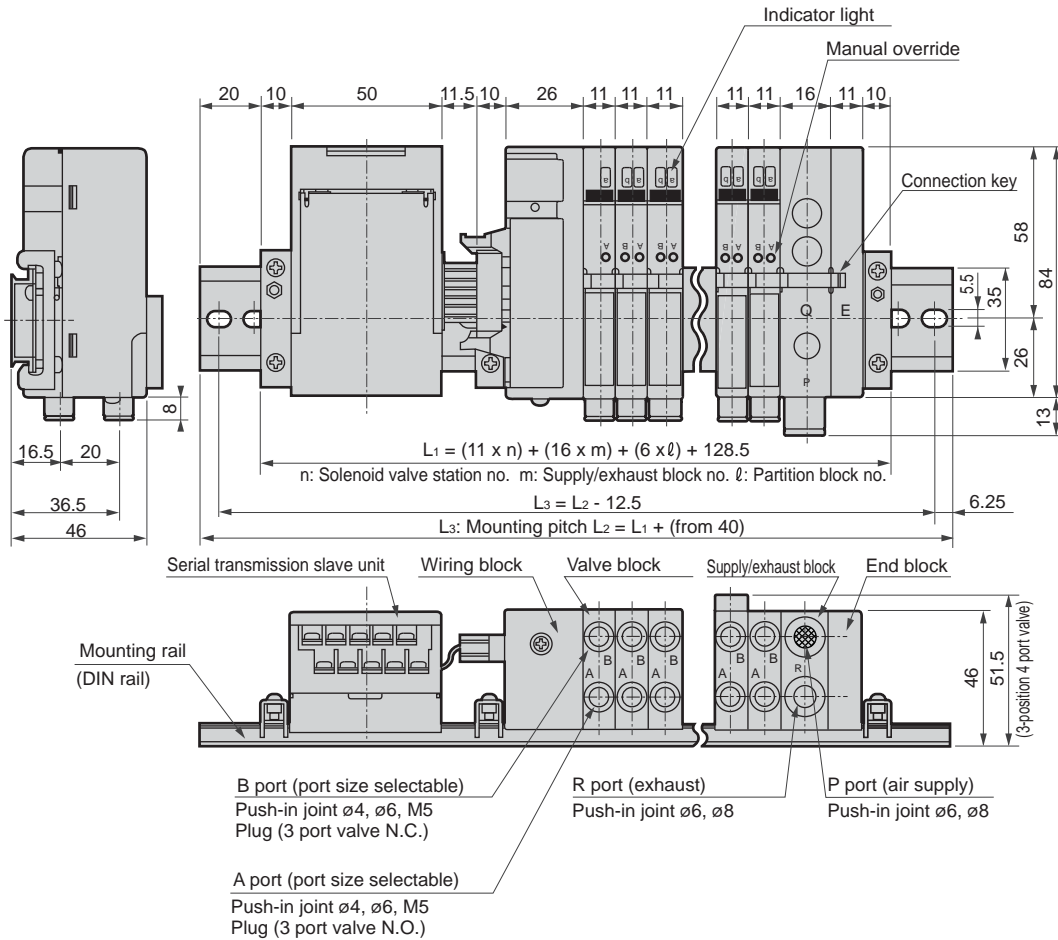

## Dimensions of piping blocks (all type common)

● Valve block,  
Push-in joint upward  
N<sub>4</sub>S0\*0-CL6 (CL4)

● Valve block,  
M5, joint  
N<sub>4</sub>S0\*0-M5

● Supply/exhaust block,  
Upward piping  
N4S0-Q-8L

● Supply/exhaust block,  
For external pilot  
N4S0-QK-L

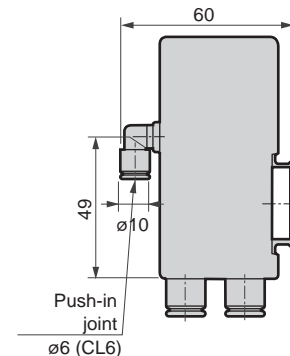
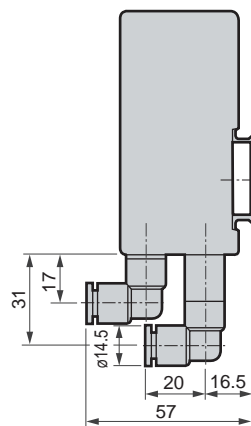
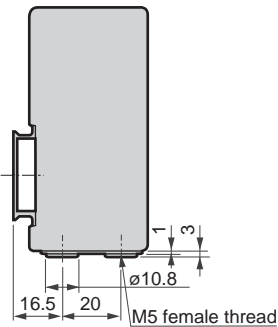
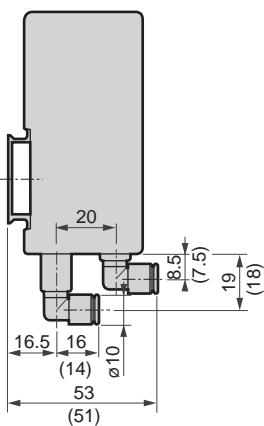

# MN3S0/MN4S0 Series

Reduced wiring block manifold: DIN rail mount

Dimensions



**MN<sub>4</sub>S0\*0-\*-\*T10-\*-\***  
**MN<sub>4</sub>S0\*0-\*-\*T11-\*-\***

Wiring block and end block are switched for right wiring specifications.

● Common gland type: (T10/T10R/T11/T11R)

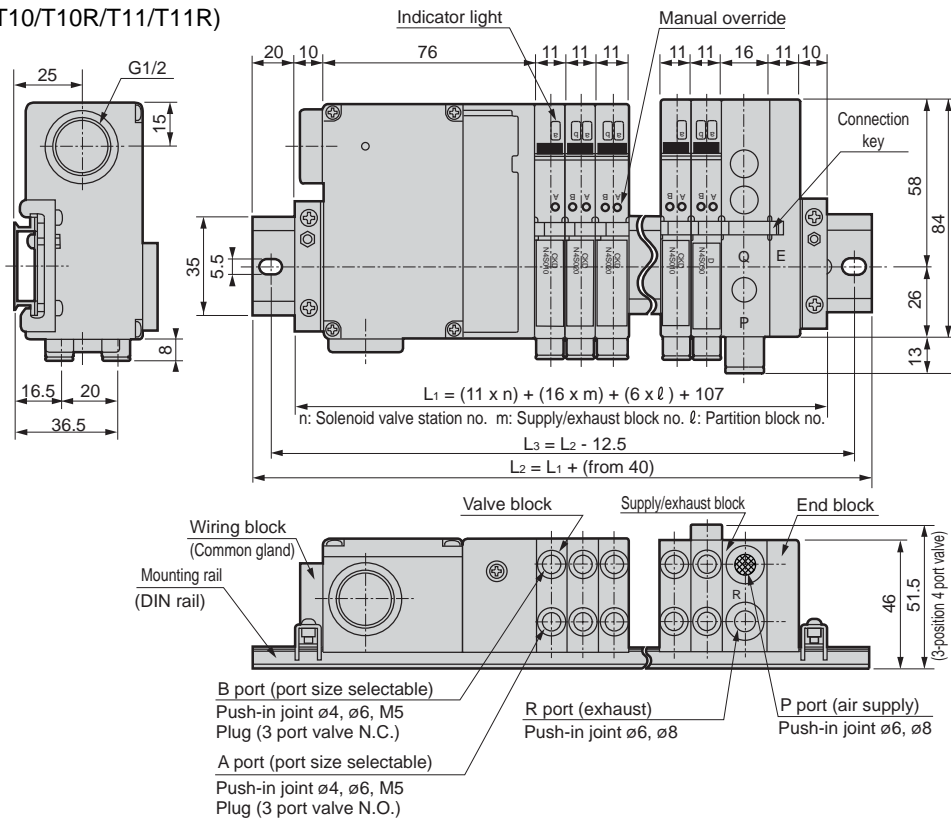

**MN<sub>4</sub>S0\*0-\*-\* (C to C2)-\*-\***

● Individual wiring connector type: (C/C0/C1/C2)

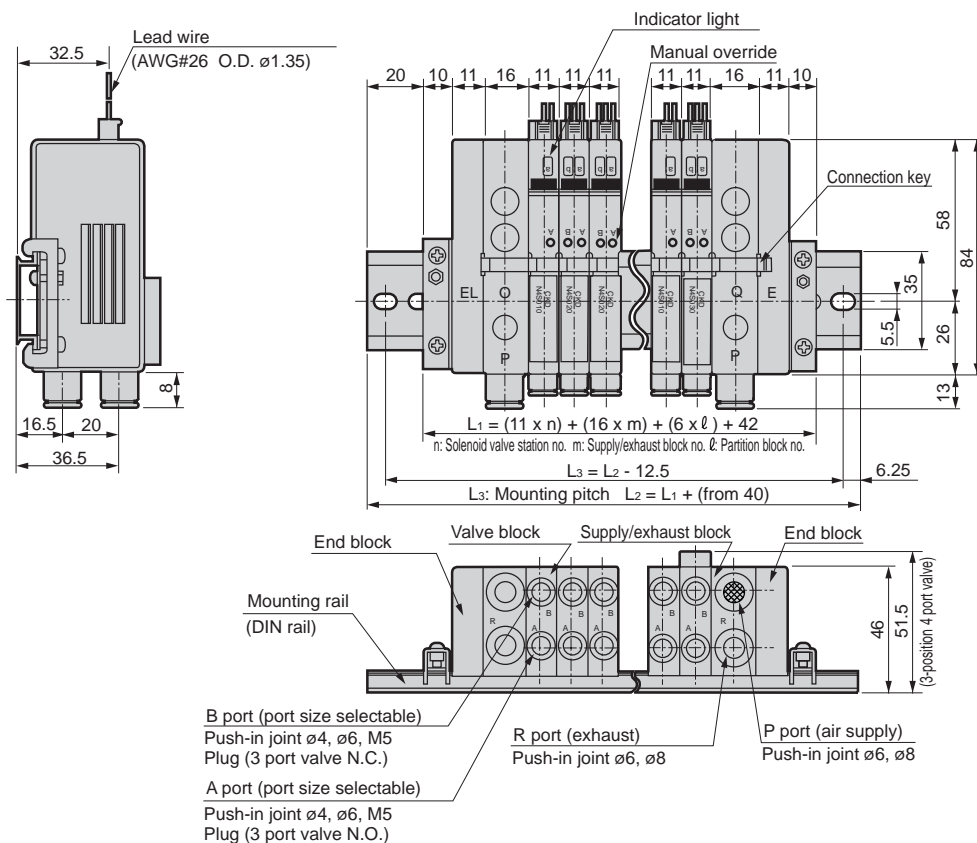

\* Refer to page 598 for the dimensions of piping blocks.

MN3E0
MN4E0
4GA/B
M4GA/B
MN4GA/B
4GA/B (Master)
W4GA/B2
W4GB4
<b>MN3S0</b>
<b>MN4S0</b>
4TB
4L2-4/LMF0
4SA/B0
4SA/B1
4KA/B
4F
PV5G/CMF
PV5/CMF
3MA/B0
3PA/B
P/M/B
NP/NAP/NVP
4F*0E
HMV/HSV
2QV/3QV
SKH
PCD/FS/FD
Ending

Reduced wiring block manifold  
 3, 4 port pilot operated valve

# MN3S0/MN4S0 Series

Reduced wiring block manifold: DIN rail mount

Dimensions



MN3E0
MN4E0
4GA/B
M4GA/B
MN4GA/B
4GA/B (Master)
W4GA/B2
W4GB4
<b>MN3S0</b>
<b>MN4S0</b>
4TB
4L2-4/LMF0
4SA/B0
4SA/B1
4KA/B
4F
PV5G/CMF
PV5/CMF
3MA/B0
3PA/B
P/M/B
NP/NAP/NVP
4F*0E
HMV
HSV
2QV
3QV
SKH
PCD/FS/FD
Ending

**MN<sub>4</sub>S0\*0\*-\*T30\*-\***

Wiring block is on the right and end block is on the left for right wiring specifications.

**MN<sub>4</sub>S0\*0\*-\*T30R\*-\***

● D sub-connector type: (T30/T30R)

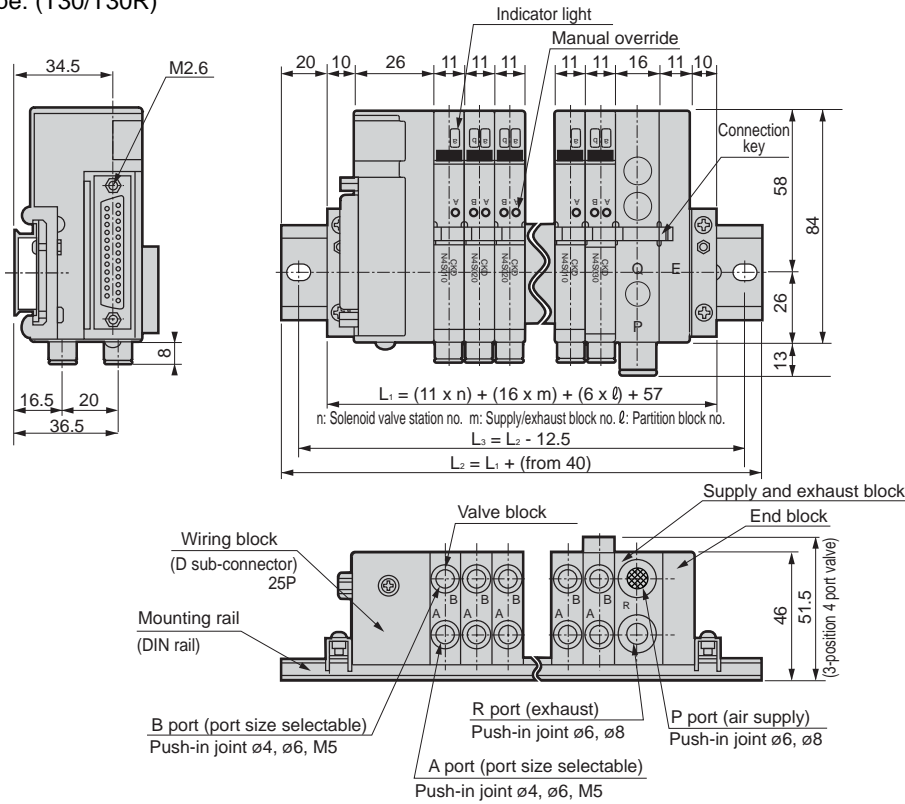

**MN<sub>4</sub>S0\*0\*-\*T50\*-\***

Wiring block is on the right and end block is on the left for right wiring specifications.

**MN<sub>4</sub>S0\*0\*-\*T50R\*-\***

● Flat cable connector type: (T50/T50R)

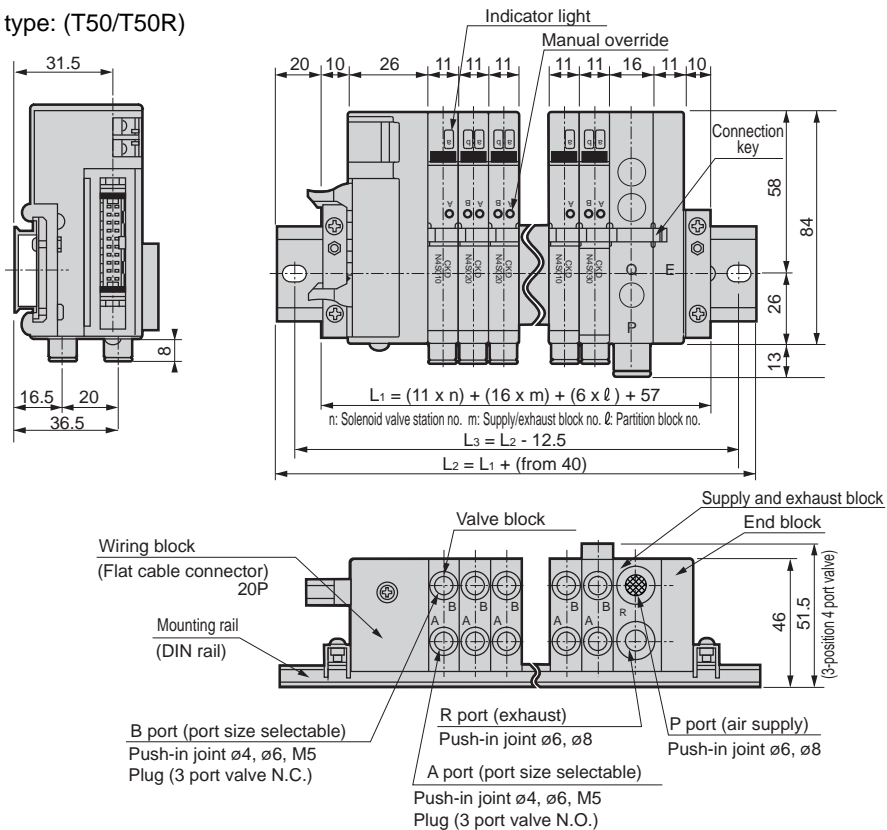

\* Refer to page 598 for the dimensions of piping blocks.

### Dimensions

#### ● N4S0-RA (pressure adjustment knob rear)

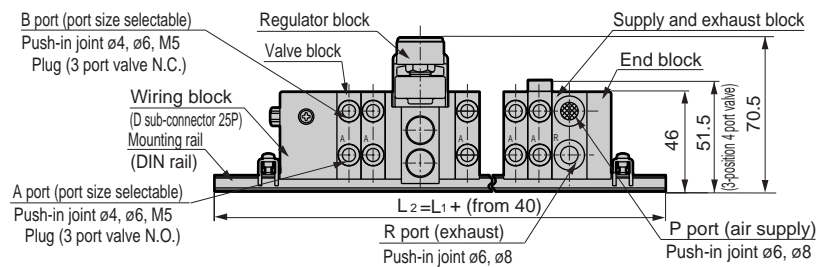
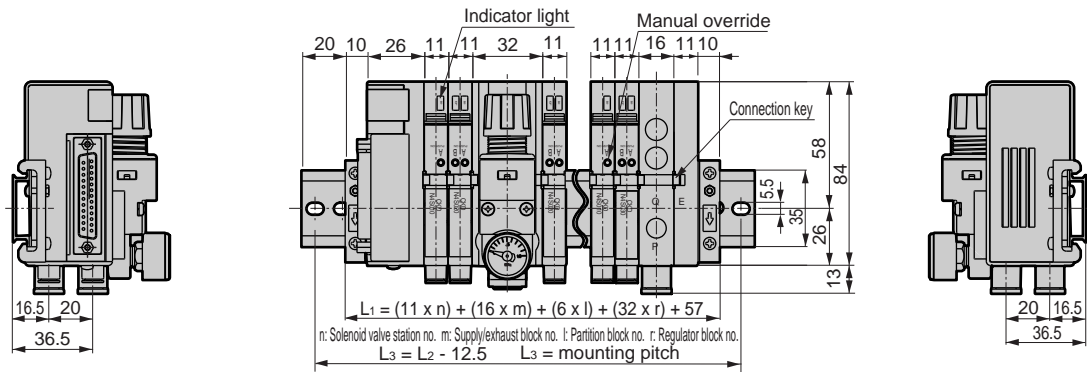

#### ● N4S0-RB (pressure adjustment knob front)

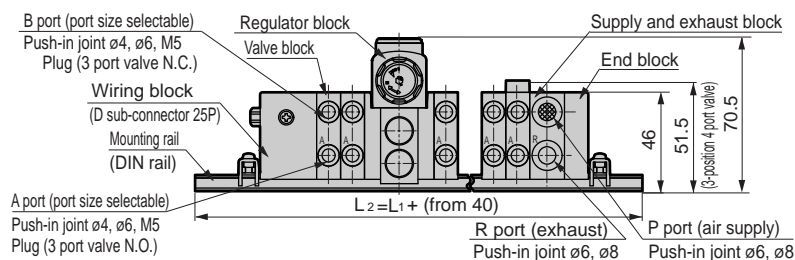
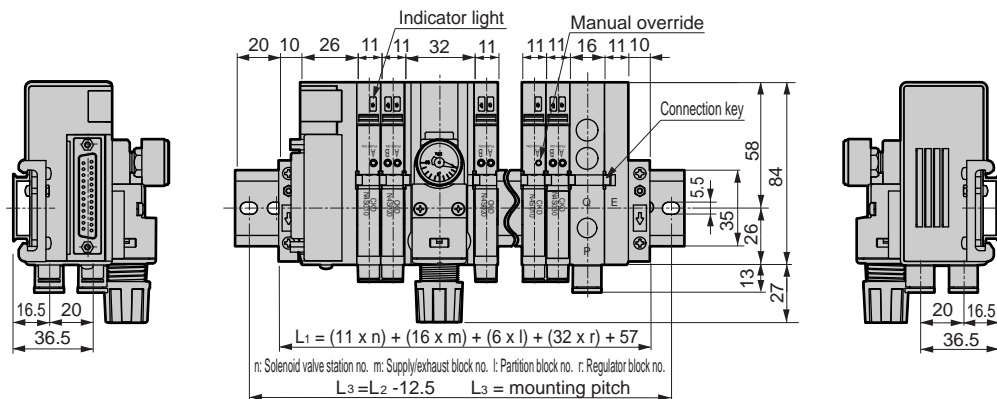

MN3E0
MN4E0
4GA/B
M4GA/B
MN4GA/B
4GA/B (Master)
W4GA/B2
W4GB4
<b>MN3S0</b>
<b>MN4S0</b>
4TB
4L2-4/LMF0
4SA/B0
4SA/B1
4KA/B
4F
PV5G/CMF
PV5/CMF
3MA/B0
3PA/B
P/M/B
NP/NAP/NVP
4F*0E
HMV
HSV
2QV
3QV
SKH
PCD/FS/FD
Ending

Reduced wiring block manifold  
3, 4 port pilot operated valve



# MT3S0/MT4S0 Series

Reduced wiring block manifold: Direct mount (limited to 8 stations)

## Dimensions



**MT<sub>4</sub>S0\*0-\*-T10-\*-\***

**MT<sub>4</sub>S0\*0-\*-T11-\*-\***

● Common gland type: (T10/T11)

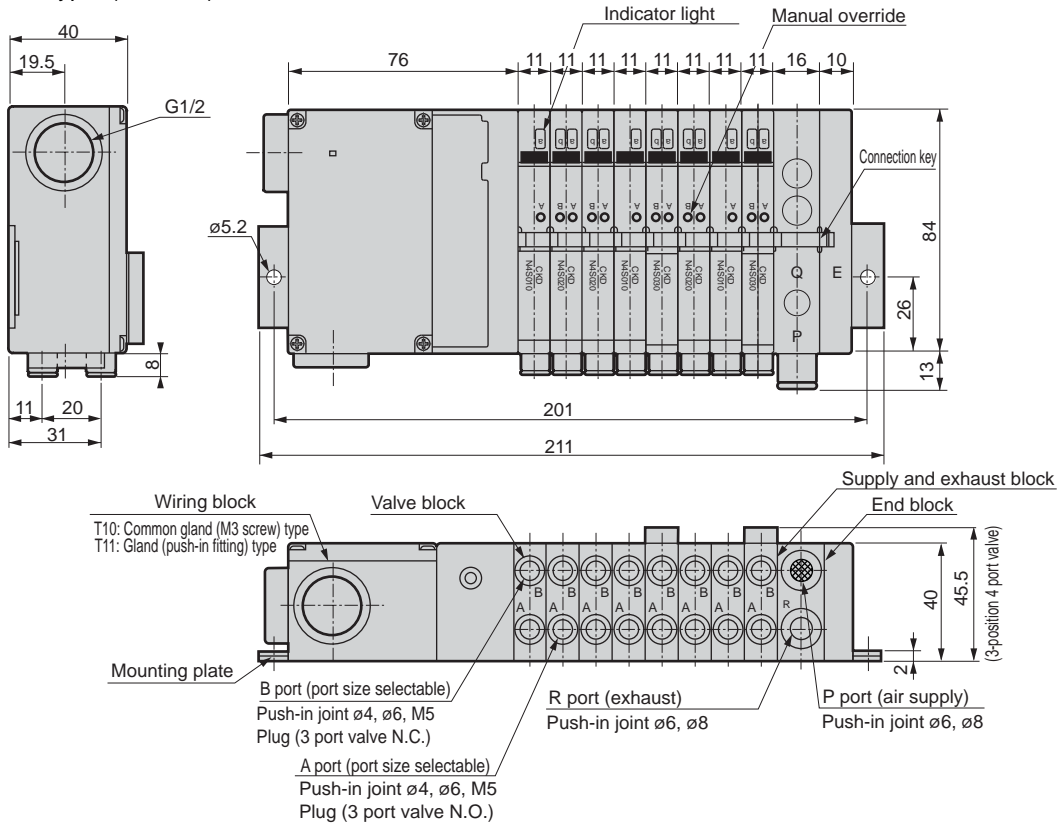

**MT<sub>4</sub>S0\*0-\*-T30-\*-\***

**MT<sub>4</sub>S0\*0-\*-T50-\*-\***

● D-sub/flat cable connector type: (T30/T50)

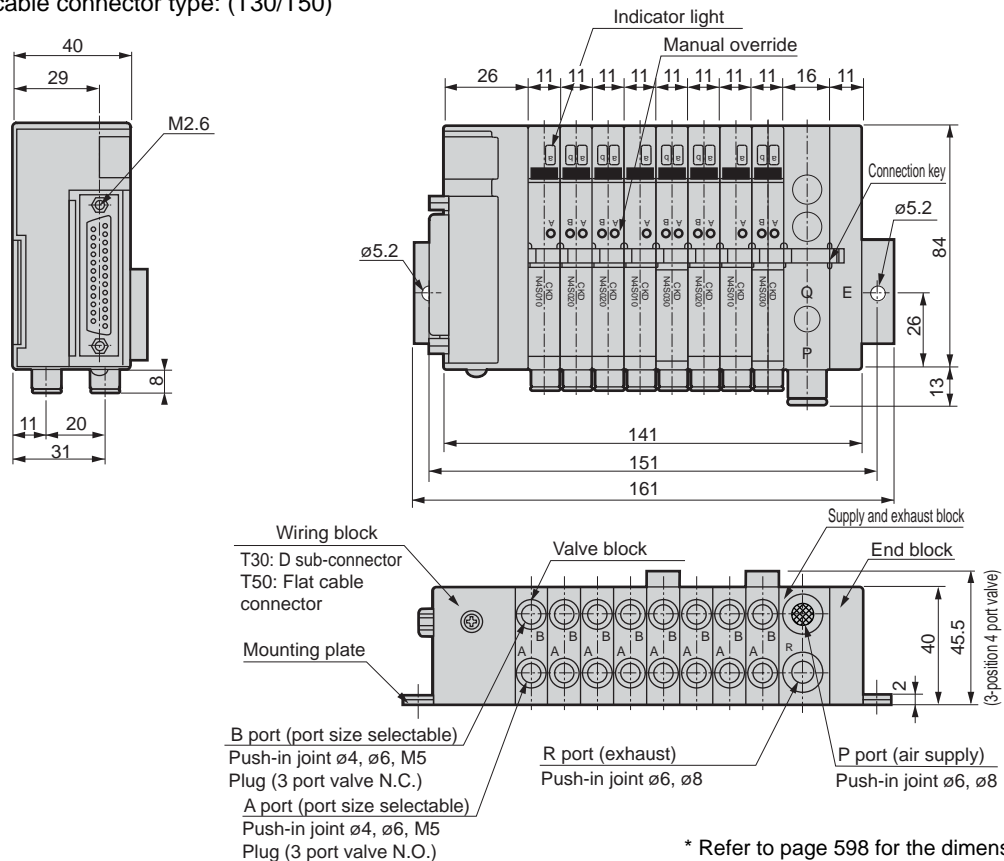

\* Refer to page 598 for the dimensions of piping blocks.

Flexible mix manifold enables easy increase/decrease of station and maintenance.

- Viewed from cylinder port, wiring block is installed on left (right) side while end block is installed on right (left) side. Install the block as sandwiching supply/exhaust block, valve block and partition block.
- Supply/exhaust block can be installed at any location adjacent to valve block. Generally, the block is installed on the right with the A/B (cylinder) port facing forward.
- Internal pilot operated or external pilot operated is automatically decided according to supply/exhaust block selection. Same valve blocks are used. Combining partition block and supply/exhaust block enables mix manifold of multi-pressure, internal pilot and external pilot.

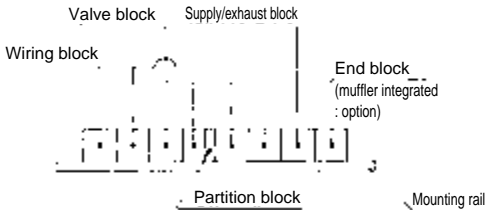

Block manifold configuration

Piping section	Piping block	<b>A</b> End block (E) Right side mount 	Left side mount 	<b>B</b> Supply and exhaust block (Q) ● Q-8      ● Q-8L ● QZ-8      ● QZ-8L 
		<b>B</b> Supply/exhaust block (QK) (QZ) (QKZ) ● QK-8      ● QK-8L      ● Q-8X      ● Q-8LX      ● QKZ-8      ● QKZ-8L ● QZ-8X 	<b>C</b> Push-in joint lateral <b>C</b> Push-in joint upward <b>C</b> Individual connector <b>D</b> Partition block 	* Joint downward should be indicated in the specification sheet. 
Wiring section	Wiring block	<b>E</b> Serial transmission unit (T6*) 	<b>F</b> D sub-connector block (T30/T30R) Left side installation      Right side installation 	<b>G</b> Flat cable connector block (T50/T50R) Left side installation      Right side installation 
		<b>H</b> Common gland block (T10/T11) Left side installation      Right side installation 		
		<b>I</b> Regulator block 		
Option	Regulator block	<b>I</b> Regulator block 		
		Related products <b>J</b> Mounting rail <b>J</b> Blanking plug <b>J</b> Push-in cartridge joint <b>J</b> Silencer <b>J</b> Push-in joint Tube remover <b>J</b> Push-in cartridge joint for supply and exhaust block 		

MN3E0  
MN4E0

4GA/B

M4GA/B

MN4GA/B

4GA/B (Master)

W4GA/B2

W4GB4

**MN3S0**  
**MN4S0**

4TB

4L2-4/  
LMF0

4SA/B0

4SA/B1

4KA/B

4F

PV5G/  
CMF

PV5/  
CMF

3MA/B0

3PA/B

P/M/B

NP/NAP/  
NVP

4F\*0E

HMV  
HSV

2QV  
3QV

SKH

PCD/  
FS/FD

Ending

Reduced wiring block manifold  
3, 4 port pilot operated valve

# MN3S0/MN4S0 Series

Reduced wiring block manifold: Block

MN3E0 MN4E0
4GA/B
M4GA/B
MN4GA/B
4GA/B (Master)
W4GA/B2
W4GB4
MN3S0 MN4S0
4TB
4L2-4/ LMF0
4SA/B0
4SA/B1
4KA/B
4F
PV5G/ CMF
PV5/ CMF
3MA/B0
3PA/B
P/M/B
NP/NAP/ NVP
4F*0E
HMV HSV
2QV 3QV
SKH
PCD/ FS/FD
Ending

## Piping section

### A End block (E)

#### Right side installation

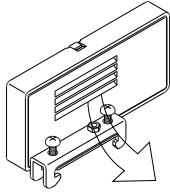

For atmospheric release, use large exhaust air flow rate EX type.  
Effective sectional area 23mm<sup>2</sup>

**N4S0** - **E**

Symbol	Descriptions
<b>E</b>	Right end block
<b>EX</b>	Muffler incorporated end block for right side

#### Left side installation

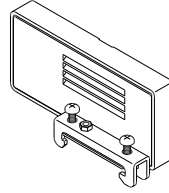

For atmospheric release, use large exhaust air flow rate EXL type.  
Effective sectional area 23mm<sup>2</sup>

**N4S0** - **EL**

Symbol	Descriptions
<b>EL</b>	Left end block
<b>EXL</b>	Muffler incorporated end block for left side

### B Supply and exhaust block (Q) (QK) (QZ)

● **Q-8**  
**QZ-8**

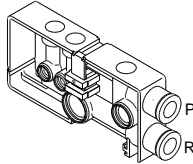

● **Q-8L**  
**QZ-8L**

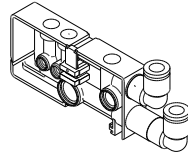

● **QK-8**

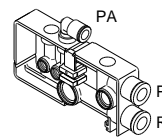

● **QK-8L**

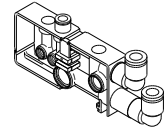

● **Q-8X**  
**QZ-8X**

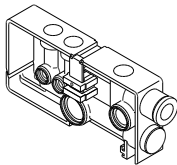

● **Q-8LX**  
**QZ-8LX**

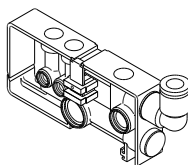

● **QKZ-8**

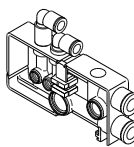

● **QKZ-8L**

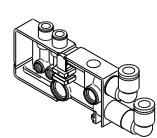

Discrete supply and exhaust block

**N4S0** - **Q** - **8**

Symbol	P port	PA port	R port	PR port	Piping direction	Applications
<b>Q-8 (X)</b>	Group ø8 joint		Group ø8 joint (Plug)		Lateral	Internal pilot
<b>Q-8L (X)</b>	Group ø8 joint		Group ø8 joint (Plug)		Upward	
<b>QK-8 (X)</b>	ø8 joint	ø6 joint			Lateral	External pilot dedicated
<b>QK-8L (X)</b>	ø8 joint	ø6 joint			Upward	
<b>QZ-8 (X)</b>	ø8 joint	—	ø8 joint (Plug)	—	Lateral	Multi-pressure circuit
<b>QZ-8L (X)</b>	ø8 joint	—	ø8 joint (Plug)	—	Upward	
<b>QKZ-8 (X)</b>	ø8 joint	ø6 joint	ø8 joint (Plug)	ø6 joint	Lateral	External pilot dedicated (Pilot circuit separate)
<b>QKZ-8L (X)</b>	ø8 joint	ø6 joint	ø8 joint (Plug)	ø6 joint	Upward	

- Air is exhausted from end block for atmospheric release type. In that case, if R port with plug is required, indicate "X" after model no.
- Port sizes ø6, 1/4 (ø6.4) of P/R ports are custom order. Model No. of ø6 is N4S0-Q-6, 1/4 is N4S0-Q-6.4
- QZ is used with Q and QK. Can not be used as a discrete part.
- A filter for preventing entry of foreign matter is incorporated in P port. (Standard)

### Piping section

#### C MN<sub>3</sub>S0 series, manifold configuration block valve

● Push-in joint Lateral

● Push-in joint Upward

● Individual connector

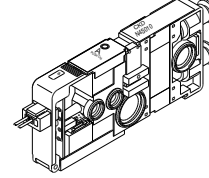
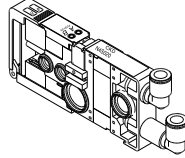
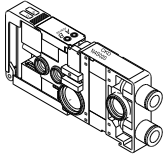

Discrete valve block

**N** 4 **S0** 1 0 - **C4** - **M1** - **3**

A	B	C	D	E	F
<b>3</b> 3 port valve <small>Two 3 port valves integrated type</small>	<b>1</b> 2-position normally closed single <b>11</b> 2-position normally open single	<b>C4</b> ø4 push-in joint lateral <b>C6</b> ø6 push-in joint lateral	<b>Blank</b> Non-locking manual override <b>M1</b> Locking manual override (tool required)	<b>Blank</b> For reduced wiring <b>C</b> Individual wiring connector Lead wire length 300 mm <b>C0</b> Individual wiring connector Lead wire length 500 mm <b>C1</b> Individual wiring connector Lead wire length 1,000 mm <b>C2</b> Individual wiring connector Lead wire length 2,000 mm	<b>3</b> 24 VDC <b>4</b> 12 VDC
<b>4</b> 4 port valve	<b>66</b> A side: N.C. / B side: N.C. type <b>67</b> A side: N.C. / B side: N.O. type <b>76</b> A side: N.O. / B side: N.C. type <b>77</b> A side: N.O. / B side: N.O. type	<b>CL4</b> ø4 push-in joint upward <b>CL6</b> ø6 push-in joint upward <b>M5</b> M5 female thread with non-rotating	<b>M2</b> Non-locking convex type <b>M3</b> Locking convex type	Standard Option Custom order	Standard Option
	<b>1</b> 2-position single solenoid <b>2</b> 2-position double solenoid <b>3</b> 3-position all ports closed <b>4</b> 3-position A/B/R connection <b>5</b> 3-position P/A/B connection				

\* For AB port with filter (foreign matter prevention) indicate F after port size symbol.

● When ordering only the cable for individual wiring connector, indicate S single or D double. Example: N4S0-INDIVIDUAL-CONNECTOR-CS1

#### D Partition block

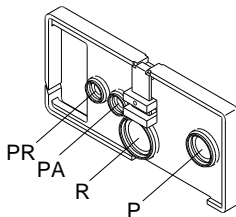

PA and PR passage of pilot pressure is not plugged except SA block. Consider this when designing system. S is used for multi-pressure specifications.

**N4S0** - **SA**

Symbol	Descriptions	
<b>SA</b>	P/R/PA/PR stop	Standard
<b>S</b>	P/R stop, PA/PR through	Option
<b>SP</b>	P stop, R/PA/PR through	
<b>SE</b>	R stop, P/PA/PR through	

MN3E0  
MN4E0

4GA/B

M4GA/B

MN4GA/B

4GA/B  
(Master)

W4GA/B2

W4GB4

**MN3S0**  
**MN4S0**

4TB

4L2-4/  
LMF0

4SA/B0

4SA/B1

4KA/B

4F

PV5G/  
CMF

PV5/  
CMF

3MA/B0

3PA/B

P/M/B

NP/NAP/  
NVP

4F\*0E

HMV  
HSV

2QV  
3QV

SKH

PCD/  
FS/FD

Ending

Reduced wiring block manifold  
3, 4 port pilot operated valve

# MN3S0/MN4S0 Series

Reduced wiring block manifold: Block

- MN3E0
- MN4E0
- 4GA/B
- M4GA/B
- MN4GA/B
- 4GA/B (Master)
- W4GA/B2
- W4GB4
- MN3S0**
- MN4S0**
- 4TB
- 4L2-4/LMFO
- 4SA/B0
- 4SA/B1
- 4KA/B
- 4F
- PV5G/CMF
- PV5/CMF
- 3MA/B0
- 3PA/B
- P/M/B
- NP/NAP/NVP
- 4F\*0E
- HMV/HSV
- 2QV/3QV
- SKH
- PCD/FS/FD
- Ending

## Wiring section

(Wiring block)

\* The wiring block is integrated with the wiring cable and cannot be ordered as a discrete part.

## E Serial transmission unit (T6\*)

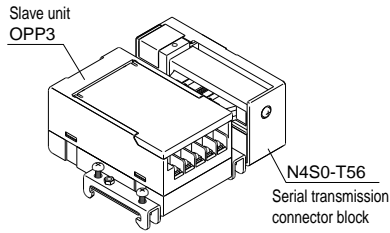

**N4S0** - **T6\***

Serial slave unit and manifold are connected with flat cable connector.  
Power source is 24 VDC dedicated.

Descriptions		Descriptions	
Serial transmission type	<b>T6A0</b>	8 points	UNIWIRES SYSTEM
	<b>T6A1</b>	16 points	Compatible with each maker's PLC, personal computer and SBC
	<b>T6C0</b>	8 points	OMRON SYSMAC α/CS1 series, C200HS, CQM1 series
	<b>T6C1</b>	16 points	CompoBus/S
	<b>T6E0</b>	8 points	SUNX Compatible with each maker's PLC
	<b>T6E1</b>	16 points	S-LINK
	<b>T6G1</b>	16 points	CC-Link
	<b>T6J0</b>	8 points	UNIWIRES H SYSTEM
	<b>T6J1</b>	16 points	Compatible with each maker's PLC, personal computer and SBC

Discrete serial transmission slave unit model no.

**N4S0** - **OPP3** - **0A**

**A** Wiring method

Symbol	Descriptions		
<b>A</b>	<b>Wiring method</b>		
<b>0A</b>	T6A0	Serial transmission type (UNIWIRES SYSTEM 8 points)	
<b>1A</b>	T6A1	Serial transmission type (UNIWIRES SYSTEM 16 points)	
<b>0C</b>	T6C0	Serial transmission type (OMRON: CompoBus/S 8 points)	
<b>1C</b>	T6C1	Serial transmission type (OMRON: CompoBus/S 16 points)	
<b>0E</b>	T6E0	Serial transmission type (SUNX: S-LINK 8 points)	
<b>1E</b>	T6E1	Serial transmission type (SUNX: S-LINK 16 points)	
<b>1G</b>	T6G1	Serial transmission type (CC-Link 16 points)	
<b>0J</b>	T6J0	Serial transmission type (UNIWIRES H SYSTEM 8 points)	
<b>1J</b>	T6J1	Serial transmission type (UNIWIRES H SYSTEM 16 points)	

### Wiring section

(Wiring block)

\* The wiring block is integrated with the wiring cable and cannot be ordered as a discrete part.

### F D sub-connector block (T30/T30R) \*MIL standards conformed (MIL-C-24308)

Left side installation	Right side installation
<p><b>N4S0</b> - <b>T30</b></p>	<p><b>N4S0</b> - <b>T30R</b></p>

### G Flat cable connector block (T50/T50R) \*MIL standards conformed (MIL-C-83503)

Left side installation	Right side installation
<p><b>N4S0</b> - <b>T50</b></p>	<p><b>N4S0</b> - <b>T50R</b></p>

Connecting OMRON transmission terminal type G71-OD16DC24V enables direct drive.  
Supply 24 VDC to external power terminal.

### H Common gland block (T10/T11)

Left side installation	Right side installation												
<p>Solenoid 14 points <b>T10/T10R</b></p> <p>Solenoid 24 points <b>T11/T11R</b></p>													
<p><b>N4S0</b> - <b>T10</b></p> <table border="1"> <thead> <tr> <th>Symbol</th> <th>Descriptions</th> </tr> </thead> <tbody> <tr> <td><b>T10</b></td> <td>M3 thread fastening gland for left</td> </tr> <tr> <td><b>T11</b></td> <td>Push tightening gland for left</td> </tr> </tbody> </table>	Symbol	Descriptions	<b>T10</b>	M3 thread fastening gland for left	<b>T11</b>	Push tightening gland for left	<p><b>N4S0</b> - <b>T10R</b></p> <table border="1"> <thead> <tr> <th>Symbol</th> <th>Descriptions</th> </tr> </thead> <tbody> <tr> <td><b>T10R</b></td> <td>M3 thread fastening gland for right</td> </tr> <tr> <td><b>T11R</b></td> <td>Push tightening gland for right</td> </tr> </tbody> </table>	Symbol	Descriptions	<b>T10R</b>	M3 thread fastening gland for right	<b>T11R</b>	Push tightening gland for right
Symbol	Descriptions												
<b>T10</b>	M3 thread fastening gland for left												
<b>T11</b>	Push tightening gland for left												
Symbol	Descriptions												
<b>T10R</b>	M3 thread fastening gland for right												
<b>T11R</b>	Push tightening gland for right												

MN3E0  
MN4E0

4GA/B

M4GA/B

MN4GA/B

4GA/B  
(Master)

W4GA/B2

W4GB4

**MN3S0**  
**MN4S0**

4TB

4L2-4/  
LMF0

4SA/B0

4SA/B1

4KA/B

4F

PV5G/  
CMF

PV5/  
CMF

3MA/B0

3PA/B

P/M/B

NP/NAP/  
NVP

4F\*0E

HMV  
HSV

2QV  
3QV

SKH

PCD/  
FS/FD

Ending

Reduced wiring block manifold  
3, 4 port pilot operated valve



# MN3S0/MN4S0 Series

Reduced wiring block manifold: Block

## I Block with regulator

**N4S0 - RA - LR - C6 - FL259661**

**N4S0 - RB - LR - C6 - FL259662**

Model no.

**A** Pressure adjustment knob direction

**B** Air supply / pressure adjustment direction

**C** Joint size  
Note 1

### ⚠ Cautions on model no. selection

Note 1: Straight joint provided as standard. Elbow is custom order part.

Note 2: When mounting regulator block on the manifold, a supply/exhaust block for pilot air is required.

Note 3: When using regulator block individually with external pressure control not from the same manifold, consult with CKD.

### Discrete regulator model no.

**RB500 - 00 M**

Note: When using the option, consult with CKD.

### Application (Consult with CKD about other applications.)

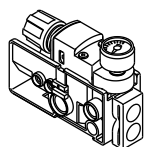
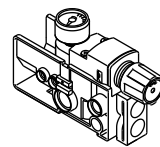
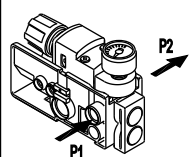
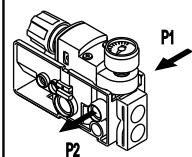
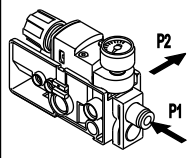
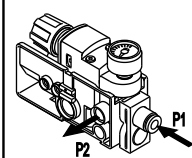
Symbol	Descriptions	Symbol	Descriptions
<b>A Pressure adjustment knob direction</b>			
RA	 Pressure adjustment gauge knob rear	RB	 Pressure adjustment gauge knob front
<b>B Air supply / pressure adjustment direction</b>			
LR		RL	
FR		FL	
Symbol	Descriptions		
<b>C Joint size</b>			
Blank	Plug (for air supply direction LR, RL)		
C6	ø6 push-in joint (straight)		
C8	ø8 push-in joint (straight)		
CL6	ø6 push-in joint (elbow)		Custom order
CL8	ø8 push-in joint (elbow)		

#### Example 1: Depressurization of internal main pressure

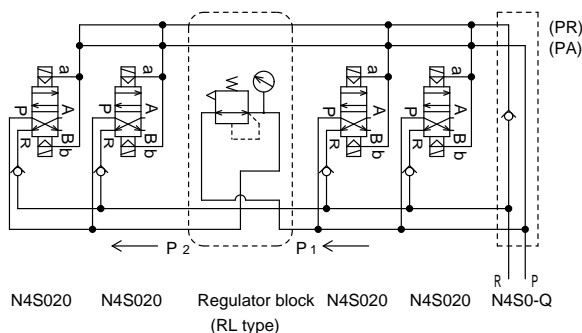

\* How to depressurize air supply pressure from supply/exhaust block (P = P<sub>1</sub>)

#### Example 2: Depressurization of external main pressure

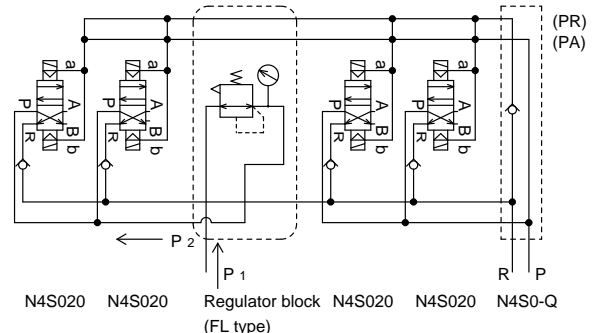

\* How to depressurize air supply pressure (P ≠ P<sub>1</sub>) directly from regulator block

# MN3S0/MN4S0 Series

## Reduced wiring block manifold: Wiring block

### J Related products

● Mounting rail

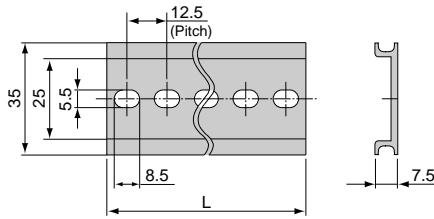

● Silencer (attachment)

**SLW-H8**

**SLW-H6**

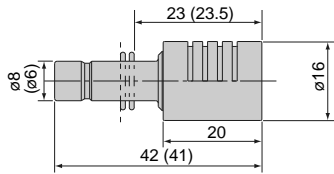

\* The value in ( ) is for H6.  
Effective sectional area 8.5 (7) mm<sup>2</sup>

● Blanking plug (attached)

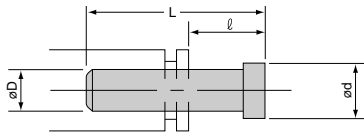

Model no.	D	L	l	d
<b>GZP4-B</b>	ø4	27	19	6
<b>GZP6-B</b>	ø6	29	19	8
<b>GZP8-B</b>	ø8	33	19	10

● Push-in joint tube remover

**N4S0-EOT4-6**

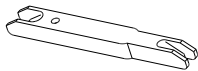

● Push-in cartridge joint

**N4S0** – JOINT – **C4**

For valve block and supply/exhaust block PA port.  
Not available for P or R port of supply/exhaust block.

Symbol	Dimensions		
<b>C4</b>	Push-in cartridge joint for ø4, ø6 tube		
<b>C6</b>			
<b>CL4</b>	Short L type push-in cartridge joint for ø4, ø6 tube		
<b>CL6</b>			
<b>CLL4</b>	Long L type push-in cartridge joint for ø4, ø6 tube		
<b>CLL6</b>			
<b>CM5</b>	M5 cartridge dedicated non rotating plate is necessary.		
<b>CMP</b>	M5 cartridge dedicated non rotating plate		
<b>CPG</b>	Plug cartridge		
<b>CMB</b>	Cartridge plug for M5 cartridge		
<b>M5-4-KIT</b>	M5 cartridge (x 2)		Non rotating plate for M5 cartridge (x 1) 
<b>M5-3-KIT</b>	M5 cartridge (x 1)	Cartridge plug for M5 cartridge (x 1) 	Non rotating plate for M5 cartridge (x 1) 

● Push-in cartridge joint for supply/exhaust block

**N4S0** – JOINT – **8**

Use compatible valve block above for pilot air supply (PA).

Symbol	Dimensions		
<b>8</b>	Push-in cartridge joint for ø8 tube		
<b>6</b>	Push-in cartridge joint for ø6 tube		
<b>8L</b>	Short L type push-in cartridge joint for ø8 tube		
<b>6L</b>	Short L type push-in cartridge joint for ø6 tube		
<b>8LL</b>	Long L type push-in cartridge joint for ø8 tube		
<b>6LL</b>	Long L type push-in cartridge joint for ø6 tube		
<b>MP</b>	Port plug for P, R		

MN3E0  
MN4E0

4GA/B

M4GA/B

MN4GA/B

4GA/B  
(Master)

W4GA/B2

W4GB4

**MN3S0**  
**MN4S0**

4TB

4L2-4/  
LMF0

4SA/B0

4SA/B1

4KA/B

4F

PV5G/  
CMF

PV5/  
CMF

3MA/B0

3PA/B

P/M/B

NP/NAP/  
NVP

4F\*0E

HMV/  
HSV

2QV  
3QV

SKH

PCD/  
FS/FD

Ending

Reduced wiring block manifold  
3, 4 port pilot operated valve

# MN3S0/MN4S0 Series

Technical data ① Notes when wiring: Serial transmission type

## Serial transmission type: Wiring method

### T6\* Serial transmission type

- The slave unit's output number differs with the manufacturer. The manifold internal connector pin number and the manifold solenoid correspond as shown below.
- Station manifolds are set in order from the left with the piping port facing forward regardless of the wiring block position.
- Internal connectors are wired in order, so there may be some void numbers depending on the number of manifolds. These void outputs cannot be used for drive other than the solenoid manifold in use.
- The working power is 24 VDC dedicated.
- A slave unit for each communication system is used. Contact CKD for the specifications on the usable PLC models, host unit models and communication systems.
- Pin no. is assigned differently based on the PLC maker, but the function assignment is the same. Layout using connectors and the triangular mark (▼) shown below as a reference. The ▼ mark is the reference for both the plug and socket.

When valve side signal array is required other than standard array, mark a or b on the wiring specifications of manifold specification sheets. For expansion, installation cable should be installed.

Circle on the wiring specifications terminal No.

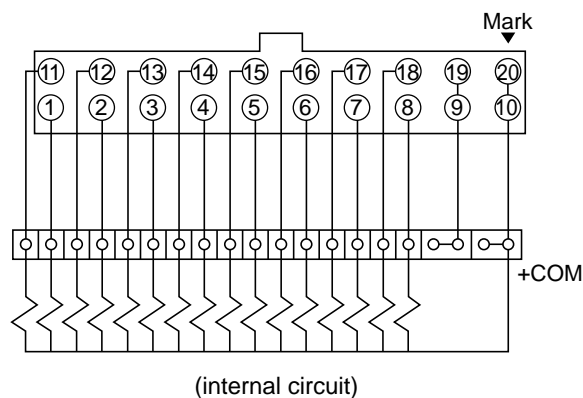
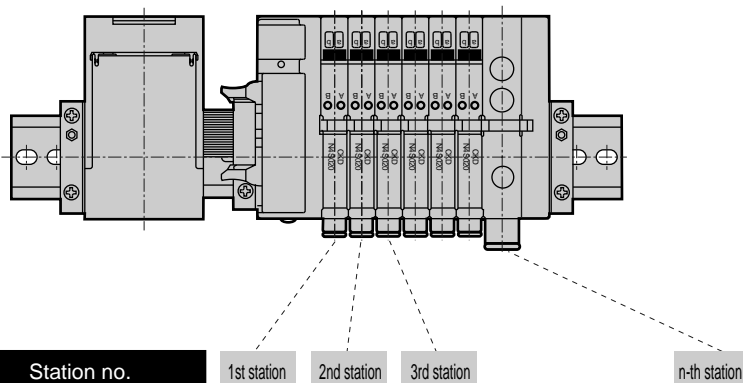

### T6\* connector pin array (example)

- For single solenoid valve (Available up to 16 stations)

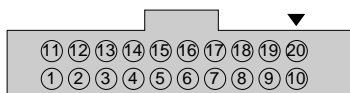

Pin No.	11	12	13	14	15	16	17	18	19	20
Valve No.	9a	10a	11a	12a	13a	14a	15a	16a		+COM
Pin No.	1	2	3	4	5	6	7	8	9	10
Valve No.	1a	2a	3a	4a	5a	6a	7a	8a		+COM

- For double solenoid valve (Available up to 8 stations)

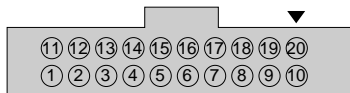

Pin No.	11	12	13	14	15	16	17	18	19	20
Valve No.	5a	5b	6a	6b	7a	7b	8a	8b		+COM
Pin No.	1	2	3	4	5	6	7	8	9	10
Valve No.	1a	1b	2a	2b	3a	3b	4a	4b		+COM

- For mix (single and double mixture) (Available up to 16 solenoids)

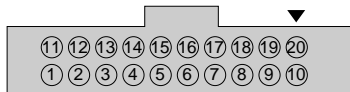

Pin No.	11	12	13	14	15	16	17	18	19	20
Valve No.	7a	7b	8a	9a	10a	10b	11a	11b		+COM
Pin No.	1	2	3	4	5	6	7	8	9	10
Valve No.	1a	2a	3a	3b	4a	4b	5a	6a		+COM

\*1: Valve Nos. 1a, 1b, 2a, 2b, etc., express the first and second stations. Letters a and b refer to solenoid a or solenoid b.

### Output No. and connector pin No.

- T6A1, T6C1, T6E1, T6J1, T6G1

Output number	0	1	2	3	4	5	6	7	8	9	10	11	12	13	14	15
Connector pin	1	2	3	4	5	6	7	8	11	12	13	14	15	16	17	18

- T6A0, T6C0, T6E0, T6J0

Output number	0	1	2	3	4	5	6	7
Connector pin	1	2	3	4	5	6	7	8

### PLC table of serial transmission

Manufacture	Series	Communication system name	Host station model no.
T6A0/T6A1 UNIWIRES	Compatible with each PLC, PC, SBC Consult with CKD for details.	UNIWIRES SYSTEM	Connect to sending unit (UW-SD-120) or each UNIWIRES interfaces
T6C0/T6C1 OMRON	SYSMAC <sup>ad</sup> /CS1 Series C200HS/CQM1 Series	CompoBus/S	C200HW-SRM21 CQM1-SRM21 SRM1-C01/C02
T6E0/T6E1 SUNX	Compatible with each PLC, PC, SBC Consult with CKD for details.	S-LINK	Connect to S-LINK controller or S-LINK control board
T6G1 MITSUBISHI CC-Link institution (CLPA)	MELSEC A Series MELSEC QnA Series MELSEC Q Series PLC, PC compatible with each CC-Link brand	CC-Link	AJ61BT11 AJ61QBT11 A1SJ61BT11 A1SJ61QBT11 QJ61BT11 (N) Connect to each maker's CC-Link master
T6J0/T6J1 UNIWIRES H SYSTEM	Compatible with each PLC, personal computer Consult with CKD for details.	UNIWIRES H SYSTEM	Connect to sending unit (UW-SD-H2) or Interface for H SYSTEM

### Common gland type: Wiring method

#### T10/T11 Common gland type

With the common gland, common wires are treated inside beforehand. Compatibility between terminal number (printed on gland cover) and manifold solenoid is as following table.

Station manifolds are set in order from the left with the piping port facing forward regardless of the wiring block position.

#### Precautions for common gland type

When using T10 type out side of panel, if required, prepare a protective cover.

For common gland type, common wiring's already internally arranged. In the following cases, man-hours for wiring is increased or wiring is impossible.

Unify power supply of manifold.

When individual contact point type PLC output unit, the contact should be wired to common.

#### Wiring methods

● For DC output unit (NPN output)

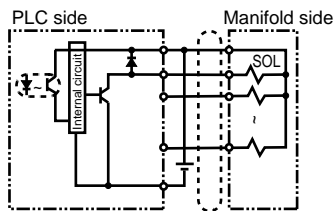

Multi conductor cable etc.

● For DC output unit (PNP output)

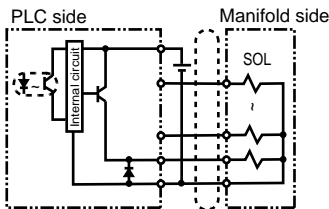

Multi conductor cable etc.

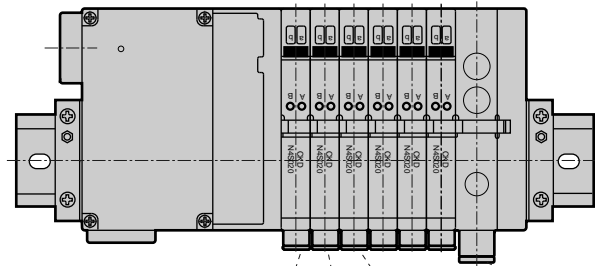

Station no.

1st station

2nd station

3rd station

...

n-th station

#### T10 Manifold internal wiring

● Up to 14 stations

Terminal layout drawing

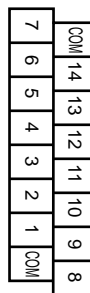

Gland No.

Polarity

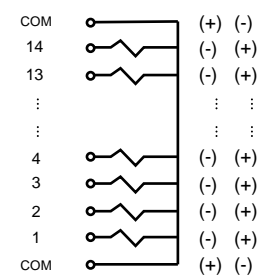

#### T11 Manifold internal wiring

● Up to 24 stations

Terminal layout drawing

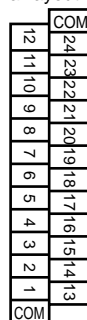

Gland No.

Polarity

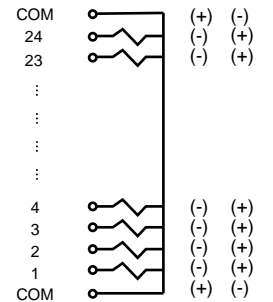

MN3E0  
MN4E0

4GA/B

M4GA/B

MN4GA/B

4GA/B  
(Master)

W4GA/B2

W4GB4

**MN3S0  
MN4S0**

4TB

4L2-4/  
LMF0

4SA/B0

4SA/B1

4KA/B

4F

PV5G/  
CMF

PV5/  
CMF

3MA/B0

3PA/B

P/M/B

NP/NAP/  
NVP

4F\*0E

HMV  
HSV

2QV  
3QV

SKH

PCD/  
FS/FD

Ending

Reduced wiring block manifold  
3, 4 port pilot operated valve

# MN3S0/MN4S0 Series

Technical data ① Notes when wiring: D sub-connector type

MN3E0 MN4E0
4GA/B
M4GA/B
MN4GA/B
4GA/B (Master)
W4GA/B2
W4GB4
<b>MN3S0 MN4S0</b>
4TB
4L2-4/ LMFO
4SA/B0
4SA/B1
4KA/B
4F
PV5G/ CMF
PV5/ CMF
3MA/B0
3PA/B
P/M/B
NP/NAP/ NVP
4F*0E
HMV HSV
2QV 3QV
SKH
PCD/ FS/FD
Ending

## D sub-connector type: Wiring method T30

### T30 Connector

Connectors used for T30/T31 wiring method are generally called D-sub connectors. These are commonly used for FA and OA devices. The 25P type is the connector designated in RS-232-C Standards that apply to personal computer communication functions. Station manifolds are set in order from the left with the piping port facing forward regardless of the wiring block position.

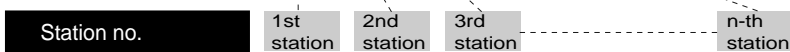
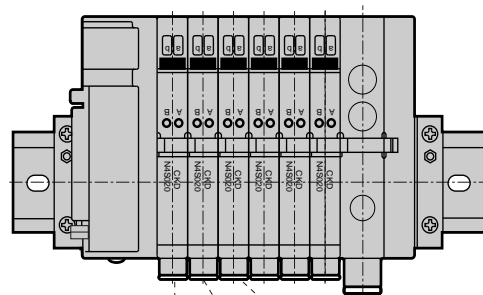

### Cautions for connector type T30

- (1) The PLC output unit's signal array and valve signal array must match.
- (2) The working power is 12/24 VDC dedicated.
- (3) The voltage could drop because of simultaneous energizing or the cable length. Confirm that the voltage drop for the solenoid is within 10% of the rated voltage.

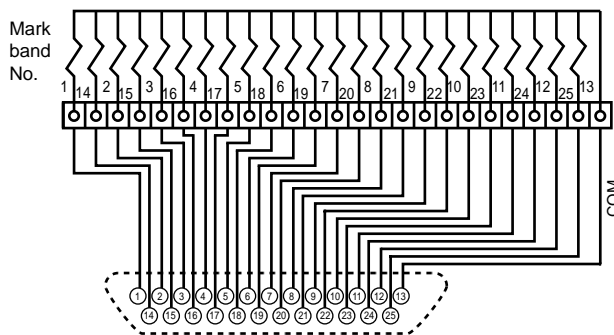

<Internal circuit>

### T30 connector pin array (example)

\*1: Valve No. 1a, 1b, 2a, 2b, etc., express the first and second stations. Letters a and b refer to solenoid a or solenoid b.

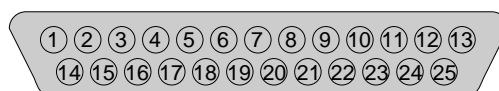

● For single solenoid valve  
(Available up to 24 stations)

Pin No.	1	2	3	4	5	6	7	8	9	10	11	12	13
Valve No.	1a	3a	5a	7a	9a	11a	13a	15a	17a	19a	21a	23a	COM
Pin No.	14	15	16	17	18	19	20	21	22	23	24	25	
Valve No.	2a	4a	6a	8a	10a	12a	14a	16a	18a	20a	22a	24a	

● For double solenoid valve  
(Available up to 12 stations)

Pin No.	1	2	3	4	5	6	7	8	9	10	11	12	13
Valve No.	1a	2a	3a	4a	5a	6a	7a	8a	9a	10a	11a	12a	COM
Pin No.	14	15	16	17	18	19	20	21	22	23	24	25	
Valve No.	1b	2b	3b	4b	5b	6b	7b	8b	9b	10b	11b	12b	

● For mix (single and double mixture)  
(Available up to 24 solenoids)

Pin No.	1	2	3	4	5	6	7	8	9	10	11	12	13
Valve No.	1a	3a	4a	5a	7a	8a	10a	11b	12b	14a	16a	17a	COM
Pin No.	14	15	16	17	18	19	20	21	22	23	24	25	
Valve No.	2a	3b	4b	6a	7b	9a	11a	12a	13a	15a	16b	17b	

### Flat cable connector type: Wiring method

#### T50 Connector

The connector used for T50 wiring method complies with MIL Standards (MIL-C-83503). The flat cable pressure welding makes wiring work easy. Pin no. is assigned differently based on the PLC manufacturer, but the function assignment is the same. Layout using connectors and the triangular mark (▼) shown below as a reference. The ▼ mark is the reference for both the plug and socket. Station manifolds are set in order from the left with the piping port facing forward regardless of the wiring block position.

#### Precautions for connector type T50

- (1) The PLC output unit's signal array and valve signal array must match. Direct connections with the PLC are limited. Use the dedicated cable for each PLC manufacturer.
- (2) The working power is 12/24 VDC dedicated.
- (3) When connecting the T50 type to a general output unit, use the + terminal (20, 10) of the 20P connector as the + side common, and use the NPN transistor output open collector type for the drive circuit.
- (4) Do not connect this manifold to the input unit as major faults could occur in this device and in peripherals. Connect this manifold to the output unit.
- (5) The voltage could drop because of simultaneous energizing or the cable length. Confirm that the voltage drop for the solenoid is within 10% of the rated voltage.

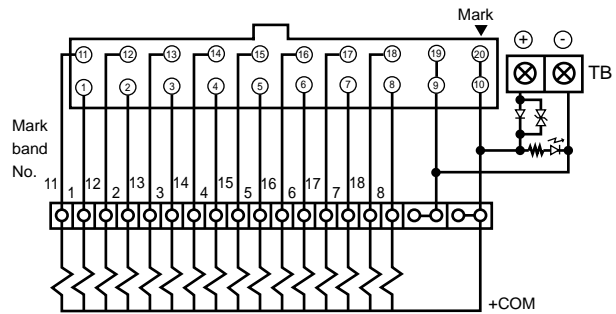
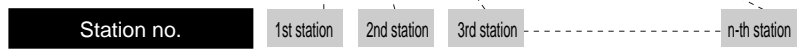
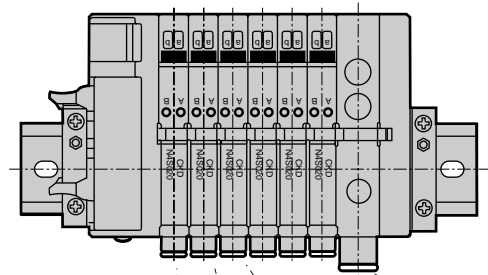

<Internal circuit>

#### T50 connector pin array (example)

\*: Valve No. 1a, 1b, 2a, 2b, etc., express the first and second stations. Letters a and b refer to solenoid a or solenoid b.

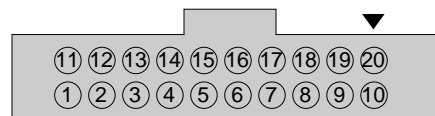

● For single solenoid valve  
(Available up to 16 stations)

Pin No.	11	12	13	14	15	16	17	18	19	20
Valve No.	9a	10a	11a	12a	13a	14a	15a	16a	- power supply	+ power supply
Pin No.	1	2	3	4	5	6	7	8	9	10
Valve No.	1a	2a	3a	4a	5a	6a	7a	8a	- power supply	+ power supply

● For double solenoid valve  
(Available up to 8 stations)

Pin No.	11	12	13	14	15	16	17	18	19	20
Valve No.	5a	5b	6a	6b	7a	7b	8a	8b	- power supply	+ power supply
Pin No.	1	2	3	4	5	6	7	8	9	10
Valve No.	1a	1b	2a	2b	3a	3b	4a	4b	- power supply	+ power supply

● For mix (single and double mixture)  
(Available up to 16 solenoids)

Pin No.	11	12	13	14	15	16	17	18	19	20
Valve No.	7a	7b	8a	9a	10a	10b	11a	11b	- power supply	+ power supply
Pin No.	1	2	3	4	5	6	7	8	9	10
Valve No.	1a	2a	3a	3b	4a	4b	5a	6a	- power supply	+ power supply

MN3E0  
MN4E0

4GA/B

M4GA/B

MN4GA/B

4GA/B  
(Master)

W4GA/B2

W4GB4

**MN3S0  
MN4S0**

4TB

4L2-4/  
LMF0

4SA/B0

4SA/B1

4KA/B

4F

PV5G/  
CMF

PV5/  
CMF

3MA/B0

3PA/B

P/M/B

NP/NAP/  
NVP

4F\*0E

HMV  
HSV

2QV  
3QV

SKH

PCD/  
FS/FD

Ending

Reduced wiring block manifold  
3, 4 port pilot operated valve



MN3E0 MN4E0
4GA/B
M4GA/B
MN4GA/B
4GA/B (Master)
W4GA/B2
W4GB4
MN3S0 MN4S0
4TB
4L2-4/ LMF0
4SA/B0
4SA/B1
4KA/B
4F
PV5G/ CMF
PV5/ CMF
3MA/B0
3PA/B
P/M/B
NP/NAP/ NVP
4F*0E
HMV HSV
2QV 3QV
SKH
PCD/ FS/FD
Ending

### How to disassemble/assemble block manifold

**CAUTION:** Be sure to turn power OFF and release pressure before increasing or decreasing the manifolds.

The procedures for changing the valve blocks, replacing the valve blocks when spent, etc., adding the supply/exhaust blocks and changing/increasing the specifications using various pressure supply devices are explained below. Refer to the individual Instruction Manuals for details.

Turn OFF power and stop the air pressure source before starting the disassembly work. When the manifold has been disassembled and assembled, if the connection key is not correctly returned between the blocks or if the wiring and end block screws are insufficiently tightened, air could leak or malfunctions could result. Confirm that the connection keys are correctly returned between the blocks and that the blocks are securely fixed onto the DIN rail before supplying the air. CKD recommends using identification marking when disconnecting the A and B port piping.

#### Replacement of valve block

- (1) Loosen the DIN rail set screw on the end block.
- (2) Open the electric cover of valve block to be replaced and blocks on both sides, and remove cable connector a, b from wiring block and common cable connector.

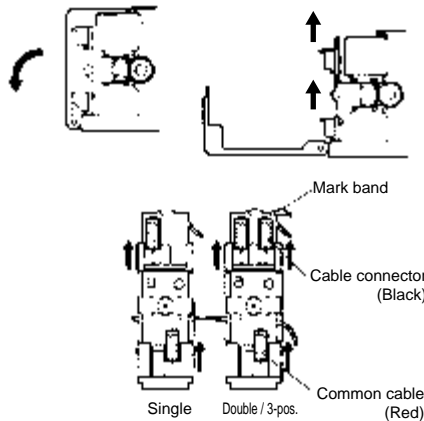

- (3) Using a flat-tip screwdriver, etc., lift up the connection key fixing the valve block to be replaced with the block on either side.

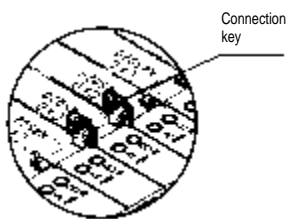

- (4) Slide the block to the end block side, and provide a space of 10 mm on each side of the block to be replaced.



Note that the wiring could break if the valve block is slid out with force.

- (5) Lift up the block's wiring cover side, and pull toward the piping port side. The block will come off the DIN rail. Open the cover and pass the wiring cable through.

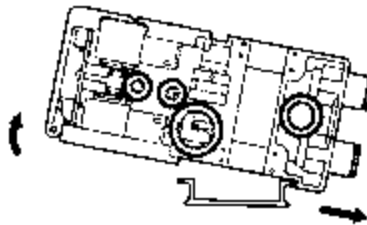

- (6) Replace with a new block. Pass the wiring cable through, and pass the latch on the bottom of the block through the port side and catch it onto the DIN rail.
- (7) Slide all of the blocks to the wiring block side so that there are no spaces between the blocks.
- (8) Push in the connection key to the groove on the top of the block.
- (9) Check the numbers on the mark band, and correctly connect the cable connectors a and b and the common connectors as originally connected.

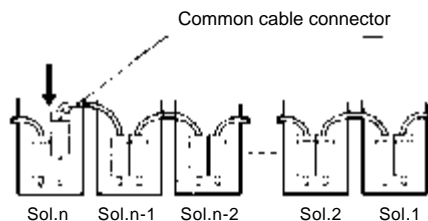

- (10) Confirm that the end block's retainer claw is caught on both sides of the DIN rail, and then tighten the set screw with a screwdriver. Appropriate tightening torque is 1.4 N·m.

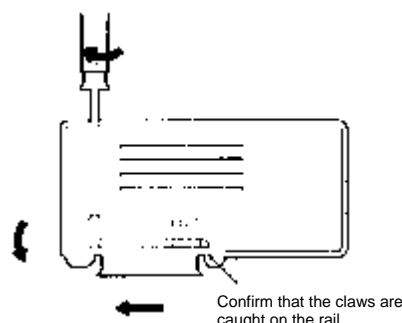

#### Increasing the valve blocks

- (1) If planning to expand the stations, designate the expansion cable on the specifications when ordering the manifold. The reserved valve block can also be designated.
- (2) If no reserve is planned, the wiring must be connected from the wiring block. Consult with CKD.

#### Installation of supply/exhaust block and partition block

- (1) The blocks are added with the same procedures as replacing the valve blocks.
- (2) Pass the cable from the wiring block and the common cable through the cover while providing slack at the cover slit on the supply/exhaust block or partition block's wiring side.
- (3) If blocks are expanded, the cable length may be too short.

#### Replacement of cartridge joint

- (1) The blocks are separated with the same procedures as replacing the valve blocks.
- (2) Using a flat-tip screwdriver, etc., release the stopper inserted from the left block port side of the joint to be replaced, and then replace the cartridge joint.
- (3) Make sure that there is no dirt, etc., on the joint's O-ring, and then set it at the original position.

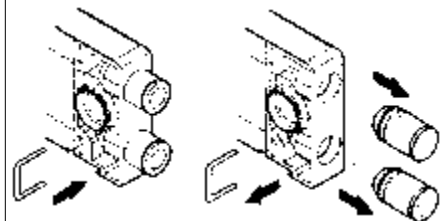

#### Checking after disassembly and assembly

Check the piping, wiring and confirm that they are correct. Check that the A, B port piping and a, b wiring is connected correctly.

### How to disassemble/assemble regulator and regulator block



**Cautions:** Be sure to turn power off and release the pressure before performing the following work.

The procedures for changing the regulator or regulator block specifications, replacing the regulator when spent, etc., adding the regulators, and disassembling and assembling are explained below. Consult with CKD.

Confirm that the connection key between blocks and the stopper plate for the regulator block are securely assembled before starting use. Refer to the MN4S0 Instruction Manual for details on handling the valve block.

#### Regulator replacement

- (1) Loosen the regulator mounting screw, and lift the regulator upward and off.
- (2) After replacing the regulator, confirm that the gasket is not deviated from the block grooves, and assemble to the original state.  
The appropriate tightening torque for the regulator mounting screw is 0.5 to 0.8 N·m.  
(Note) Pressure reduction may not be possible if the regulator's knob direction is reversed from the original position when replaced. Assemble a regulator which has been removed in the original state.

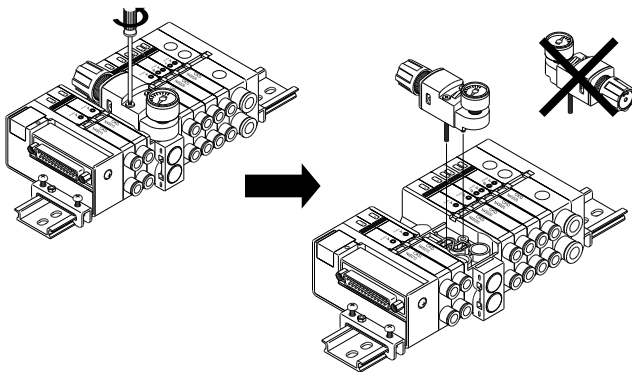

#### Regulator block replacement

- (1) Remove the regulator body. (Refer to the section above for the removal methods.)
- (2) Open the cover of the wiring block for the valve blocks on either side of the regulator block, and disconnect the cable connector a (and b) and common cable connector for the (n + 1) station valve block.

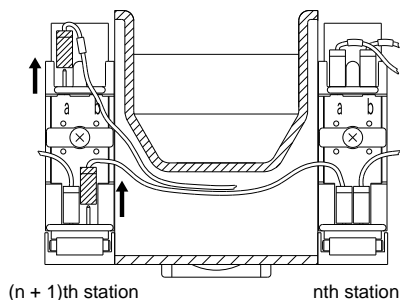

- (3) Using a flat-tip screwdriver, etc., lift up the connection key fixing the regulator block with the valve blocks on either side.

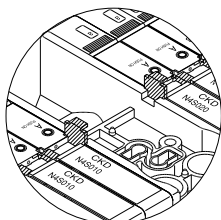

- (4) Loosen the DIN rail set screw on the end block.
- (5) Slide the block to the end block side, and provide a space of 10 mm on each side of the regulator block to be replaced.

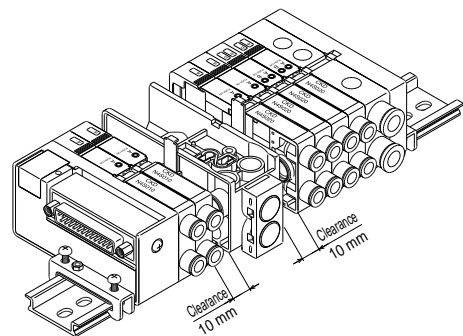

- (6) Lift up the side opposite the block piping port, and pull toward the piping port side to remove the block from the DIN rail. (Refer to the following diagram (1) → (3))

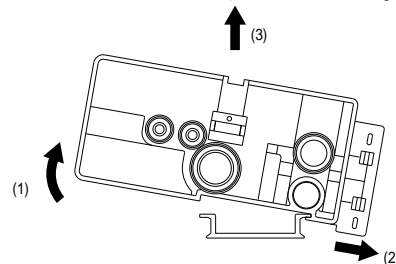

- (7) Replace the block, and mount the blocks onto the DIN rail in the reverse order that they were removed.
- (8) Slide all of the blocks to the wiring block side so that there are no spaces between the blocks.
- (9) Push in the connection key to the groove on the top of the block.
- (10) Check the numbers on the mark band, and correctly connect the cable connectors a and b and the common connectors as originally connected.
- (11) Confirm that the end block's retainer claw is caught on both sides of the DIN rail, and then tighten the set screw with a screwdriver. Appropriate tightening torque of set screw is 1.4 to 1.5 N·m.

#### Regulator block cartridge joint replacement

- (1) Separate the blocks in the same process as the "Replacing the regulator block" procedures.
- (2) Using a flat-tip screwdriver, etc., release the stopper right side of the joint to be replaced, and then replace the joint. (Refer to the following diagram (1) → (2))
- (3) Make sure that there is no dirt, etc., on the joint's O-ring, and then set it at the original position.

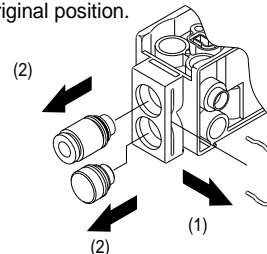

MN3E0  
MN4E0

4GA/B

M4GA/B

MN4GA/B

4GA/B  
(Master)

W4GA/B2

W4GB4

MN3S0  
MN4S0

4TB

4L2-4/  
LMF0

4SA/B0

4SA/B1

4KA/B

4F

PV5G/  
CMF

PV5/  
CMF

3MA/B0

3PA/B

P/M/B

NP/NAP/  
NVP

4F\*OE

HMV/  
HSV

2QV  
3QV

SKH

PCD/  
FS/FD

Ending

Reduced wiring block manifold  
3, 4 port pilot operated valve

# MN3S0/MN4S0 Series

## Block manifold specifications

### How to fill out block manifold specification sheet

● Manifold model no. (example) Refer to pages 603 to 609 for part no. and details.

**MN<sup>3</sup><sub>4</sub>S0** **8** **0-** **CX** - **MX** **T50** - **7** - **3**

DIN rail mount type Solenoid position Port size Manual override Wiring method Valve block station number Voltage

Part name	Model no.	Installation position																									Qty.								
		1	2	3	4	5	6	7	8	9	10	11	12	13	14	15	16	17	18	19	20	21	22	23	24	25									
Wiring block	N4S0- T50	○																										1							
Valve block	N4S0 1 0-C4-M1			○	○	○	○																					4							
	N4S0 2 0-C6								○	○																		2							
	N4S0 4 0-C6										○																	1							
	N3S0 0-																											1							
Supply and exhaust block	N4S0-Q 8																											1							
	N4S0-Q Z 8	○																										1							
Partition block	N4S0- (Note 1)								S																			1							
End block	N4S0-E													○														1							
Mounting rail	L <sub>2</sub> =	Accessories	Blanking plug		GZP4-B		Silencer		SLW-H8																										
			Blanking plug		GZP6-B		Cable with D-sub connector		N4T-CABLE-DO*-*																										
			Blanking plug		GZP8-B		Push-in joint tube remover (standard)		<input type="checkbox"/> Not required (Check)																										

(Note 1) When using partition blocks, indicate the model SA, S, SP or SE for the installation position No.

### Preparing the manifold specifications

- Complete from the left end, with the piping port facing forward.  
(Indicate the block type selected from the block part components (pages 603 to 609) and the layout instructions.)
- Indicate the total number of blocks designated in the required quantity on the right of the table.
- Indicate the total number of required accessories.
- Indicate the mounting rail length. (Indicate only when a length other than the standard length is required.)
- Manifold specifications are available for individual series, so fill out corresponding specifications.
  - MN<sup>3</sup><sub>4</sub>S0 ..... Page 618
  - MT<sup>3</sup><sub>4</sub>S0 ..... Page 619
  - MN<sup>3</sup><sub>4</sub>S0 (regulator block mounting) ..... Page 620

### Calculating the DIN rail length

Manifold length L<sub>1</sub> = (11 x n) + (16 x m) + (6 x 0) + 57 (Wiring method T30/T50 type)  
 = (11 x n) + (16 x m) + (6 x 0) + 107 (Wiring method T10/T11 type)  
 = (11 x n) + (16 x m) + (6 x 0) + 128.5 (Wiring method T6\* type)  
 = (11 x n) + (16 x m) + (6 x 0) + 42 (Wiring method Individual wiring type)  
 n: Valve block no. 0: Partition block no. m: Supply/exhaust block no.

DIN rail length L<sub>2</sub> = L<sub>2</sub>' x 12.5  
 L<sub>2</sub>' =  $\frac{L_1 + 40}{12.5}$  ⇨ Integer round up decimal point, rail mount pitch L<sub>3</sub> = L<sub>2</sub> - 12.5

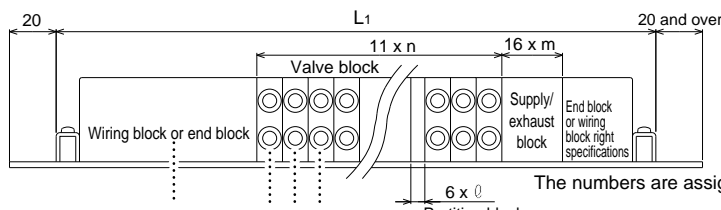
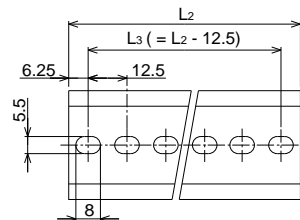

The numbers are assigned from the left facing the port side. This also applies for the wiring block right specifications.

Installation position No. 1 2 3 4 ..... Serial No. for all blocks.  
 Valve No. 1 2 3 ..... Serial No. for only the valve block.

When expanding the stations, add the number of stations. With the standard calculations, valve blocks can be expanded for two stations.

### References circuit diagram

This is the circuit diagram from the manifold (example) above.

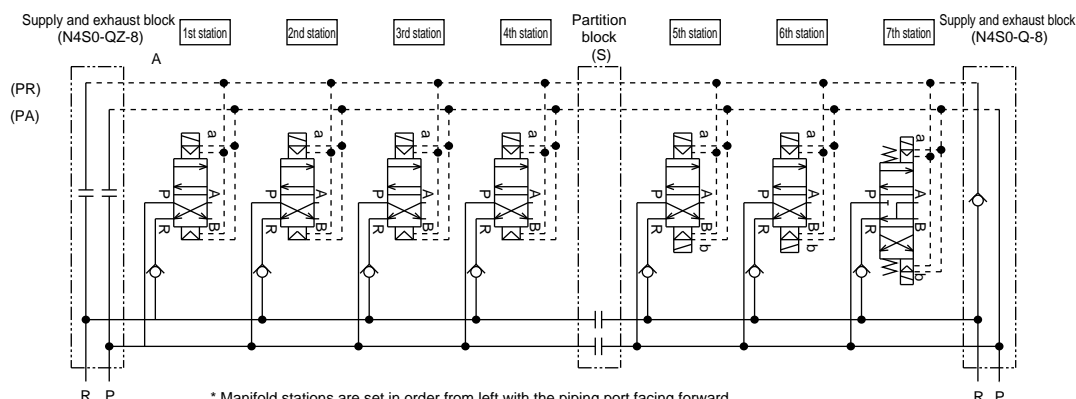

\* Manifold stations are set in order from left with the piping port facing forward.  
 (The wiring block, supply/exhaust block, partition block and end block are not included in the number of manifold stations.)

### How to fill out wiring specifications form

\* Not required for standard wiring

#### ● Notes of wiring specifications

- (1) With the wiring block and valve block, common wires are treated inside beforehand.
- (2) The connector pin and terminal block No. are set to correspond with the solenoid No. according to the T10, T11, T30 and T50 wiring methods. Refer to the precautions for each wiring method and indicate the numbers. Contact CKD when designating specifications other than the standard wiring specifications.
- (3) If the expansion valve specification might change, the expansion cable must be provided beforehand. (Two expansion valves are provided with the standard wiring.)

Indicate ○ mark for each pin connector or terminal No. in the wiring Specifications field. (Refer to example below.)

Note that the supply/exhaust block must be installed on the end block side to ensure space for storing the expansion cables. If 5 or more cable wires need to be installed, an extra supply/exhaust block must be provided. If the single type might be changed to a double type, indicate the valve numbers a and b, circle b, and circle the terminal No. In this case, the supply/exhaust block does not need to be expanded even if there are more than 5 cables.

#### ● Example (Completed based on the previous page's manifold specifications.)

Connector pin or gland No.					Valve No.														
T10	T11	T30	(T50)	T	1	2	3	4	5	6	7	8	9	10	11	12	13	14	
1	1	1	1	1	a														
2	2	14	2	2		a													
3	3	2	3	3			a												
4	4	15	4	4				a											
5	5	3	5	5					a										
6	6	16	6	6					(b)										Reserve cable
7	7	4	7	7						a									
8	8	17	8	8						(b)									Reserve cable
9	9	5	9	9															
10	10	18	10	10															
11	11	6	11	11															
12	12	19	12	12								a							
13	13	7	13	13								b							
14	14	20	14	14															Reserve cable
COM	15	8	15	15															
COM	16	21	16	16															
	17	9	17	17															
	18	22	18	18															
	19	10	19	19															
	20	23	20	20															
	21	11	21	21															

With standard wiring, two expansion cables are provided.

For the reserved cable after the last wiring, shift by one line and indicate.

- MN3E0
- MN4E0
- 4GA/B
- M4GA/B
- MN4GA/B
- 4GA/B (Master)
- W4GA/B2
- W4GB4
- MN3S0
- MN4S0
- 4TB
- 4L2-4/LMF0
- 4SA/B0
- 4SA/B1
- 4KA/B
- 4F
- PV5G/CMF
- PV5/CMF
- 3MA/B0
- 3PA/B
- P/M/B
- NP/NAP/NVP
- 4F\*0E
- HMV/HSV
- 2QV/3QV
- SKH
- PCD/FS/FD
- Ending

Reduced wiring block manifold  
3, 4 port pilot operated valve



# MT<sup>3</sup><sub>4</sub>S<sup>0</sup> Direct mount type Block manifold specifications

Issue / /

Your company name

Contact

Order No.

● Contact      ● Quantity      set      ● Request date

Slip No.	Order No.
----------	-----------

● Manifold model no.

**MT<sup>3</sup><sub>4</sub>S<sup>0</sup>**       **0-**    -    - **8** -   

Direct mount type    Solenoid position    Port size    Manual override    Wiring method    Valve block station number    Voltage

When completing this form, select the type from the "Block part components" (pages 603 to 609).

Part name (page)	Model no.	Installation position											Qty.	
		1	2	3	4	5	6	7	8	9	10	11		
Wiring block (page 607)	N4S0- <span style="border:1px dashed black; padding:2px 10px;">  </span>													
Valve block (page 605)	N4S0- <span style="border:1px dashed black; padding:2px 10px;">  </span> 0- <span style="border:1px dashed black; padding:2px 10px;">  </span>													
	N4S0- <span style="border:1px dashed black; padding:2px 10px;">  </span> 0- <span style="border:1px dashed black; padding:2px 10px;">  </span>													
	N4S0- <span style="border:1px dashed black; padding:2px 10px;">  </span> 0- <span style="border:1px dashed black; padding:2px 10px;">  </span>													
	N4S0- <span style="border:1px dashed black; padding:2px 10px;">  </span> 0- <span style="border:1px dashed black; padding:2px 10px;">  </span>													
	N4S0- <span style="border:1px dashed black; padding:2px 10px;">  </span> 0- <span style="border:1px dashed black; padding:2px 10px;">  </span>													
	N3S0- <span style="border:1px dashed black; padding:2px 10px;">  </span> 0- <span style="border:1px dashed black; padding:2px 10px;">  </span>													
	N3S0- <span style="border:1px dashed black; padding:2px 10px;">  </span> 0- <span style="border:1px dashed black; padding:2px 10px;">  </span>													
Supply/exhaust block (page 605)	N4S0-Q <span style="border:1px dashed black; padding:2px 10px;">  </span> - <span style="border:1px dashed black; padding:2px 10px;">  </span>													
End block (page 605)	N4S0-E <span style="border:1px dashed black; padding:2px 10px;">  </span>													
Accessories (page 609)	Blanking plug    GZP4-B			Silencer	SLW-H8				Cable with D-sub connector	N4T-CABLE-DO**				
	Blanking plug    GZP6-B			Silencer	SLW-H6				Push-in joint tube remover (Standard)	<input type="checkbox"/> Not required (Check)				
	Blanking plug    GZP8-B													

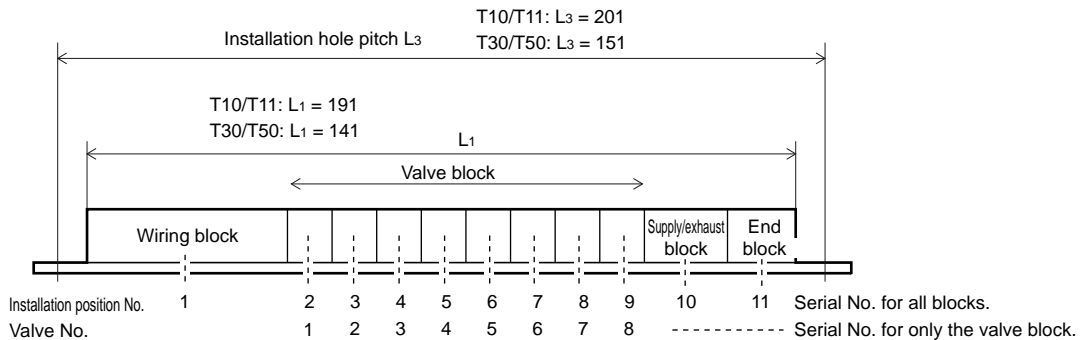

## ● Wiring specifications (not required for standard wiring)

Connector pin or gland No.					Valve No.							
T10	T11	T30	T50		1	2	3	4	5	6	7	8
1	1	1	1	1								
2	2	14	2	2								
3	3	2	3	3								
4	4	15	4	4								
5	5	3	5	5								
6	6	16	6	6								
7	7	4	7	7								
8	8	17	8	8								
9	9	5	9	-power supply								
10	10	18	10	+power supply								
11	11	6	11	11								
12	12	19	12	12								
13	13	7	13	13								
14	14	20	14	14								
COM	15	8	15	15								
COM	16	21	16	16								
	17	9	17	17								
	18	22	18	18								
	19	10	19	-power supply								
	20	23	20	+power supply								
	21	11	21	21								
	22	24	22	22								
	23	12	23	23								
	24	25	24	24								
	COM	13COM	25	25								
	COM		26	26								

When T50 wiring is used, connector pin numbers 9, 10, 19, and 20 cannot be designated because they are used for external input power.

MN3E0  
MN4E0

4GA/B

M4GA/B

MN4GA/B

4GA/B  
(Master)

W4GA/B2

W4GB4

**MN3S0**  
**MN4S0**

4TB

4L2-4/  
LMF0

4SA/B0

4SA/B1

4KA/B

4F

PV5G/  
CMF

PV5/  
CMF

3MA/B0

3PA/B

P/M/B

NP/NAP/  
NVP

4F\*0E

HMV  
HSV

2QV  
3QV

SKH

PCD/  
FS/FD

Ending

Reduced wiring block manifold  
3, 4 port pilot operated valve

